

Unesco technical papers
in marine science

An intercomparison of some current meters, II

sponsored by
SCOR, IAPSO, and Unesco

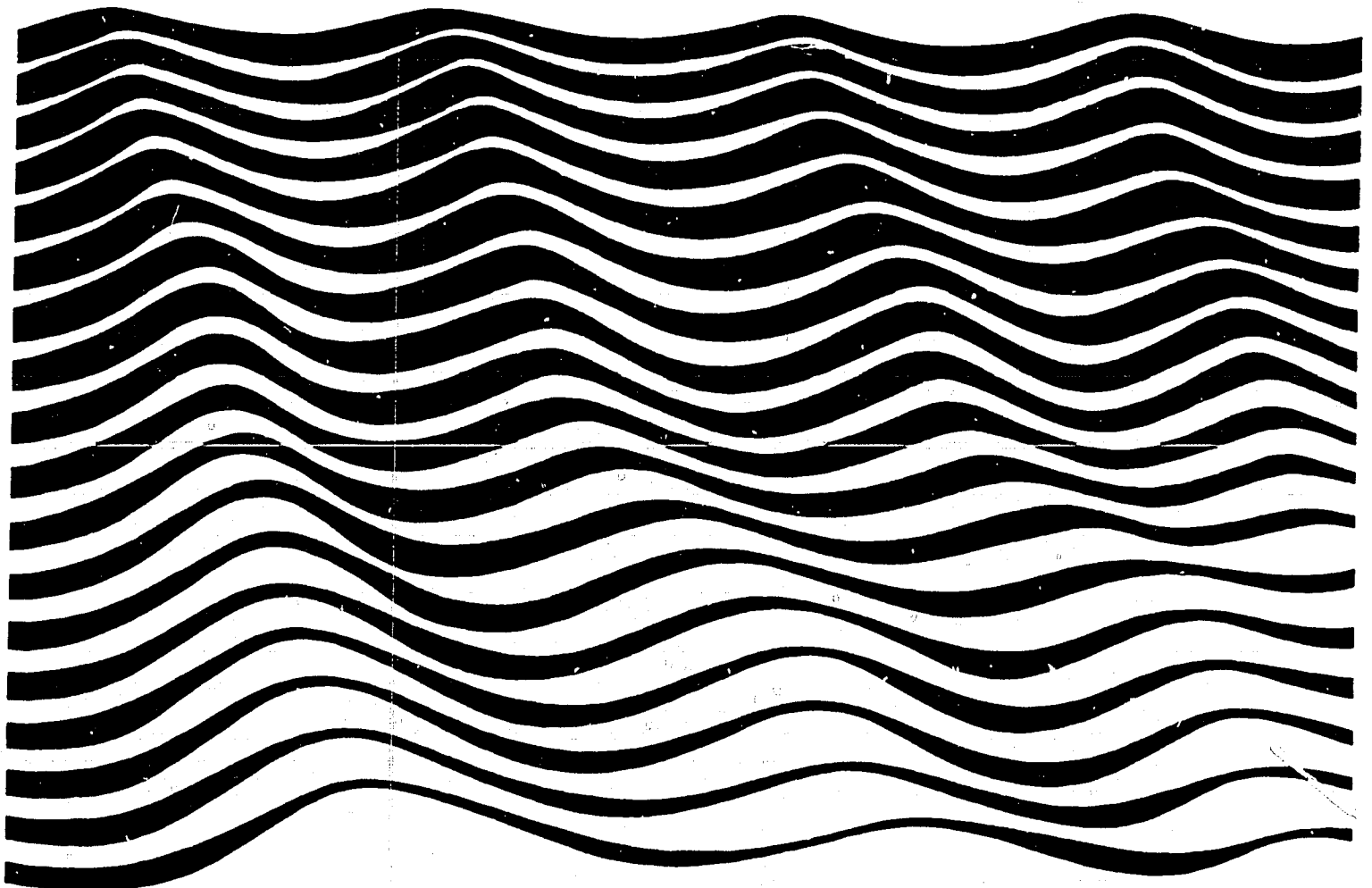

Unesco

UNESCO TECHNICAL PAPERS IN MARINE SCIENCE

			SCOR
1.	First report of the joint panel on oceanographic tables and standards held at Copenhagen, 5-6 October 1964; sponsored by Unesco, ICES, SCOR, IAPO	1965	WG 10
2.	Report of the first meeting of the joint group of experts on photo-synthetic radiant energy held at Moscow, 5-9 October 1964; sponsored by Unesco SCOR, IAPO	1965	WG 15
3.	Report on the intercalibration measurements in Copenhagen, 9-13 June 1965; organized by ICES		—
4.	Second report of the joint panel on oceanographic tables and standards held in Rome, 8-9 October 1965; sponsored by Unesco, ICES, SCOR, IAPO	1966	WG 10
5.	Report of the second meeting of the joint group of experts on photo-synthetic radiant energy held at Karuizawa, 15-19 August 1966; sponsored by Unesco, SCOR, IAPO	1966	WG 10
6.	Report of a meeting of the joint group of experts on radiocarbon estimation of primary production held at Copenhagen, 24-26 October 1966; sponsored by Unesco, SCOR, ICES	1967	WG 20
(Note : Nos. 1 to 6 are out of stock) "			
7.	Report of the second meeting of the Committee for the Check-list of the Fishes of the North Eastern Atlantic and of the Mediterranean, London 20-22 April 1967 Procès-verbal de la 2è réunion du Comité pour le catalogue des poissons du Nord-Est atlantique et de la Méditerranée, Londres, 20-22 avril 1967	1968	—
8.	Third report of the joint panel on oceanographic tables and standards, Berne, 4-5 October 1967; sponsored by Unesco, ICES, SCOR, IAPO	1968	WG 10
9.	Report on intercalibration measurements, Leningrad, 24-28 May 1966 and Copenhagen, September 1966; organized by ICES	1969	—
10.	Guide to the Indian Ocean Biological Centre (IOBC), Cochin (India), by the Unesco Curator 1967-1969 (Dr. J. Tranter)	1969	
11.	An intercomparison of some current meters, report on an experiment at WHOI Mooring Site "D", 16-24 July 1967 by the working group on Continuous Current Velocity Measurements; sponsored by SCOR, IAPSO and Unesco	1969	WG 21
12.	Check-list of the fishes of the north-eastern Atlantic and of the Mediterranean (report of the third meeting of the Committee, Hamburg, 8-11 April 1969)	1969	—
13.	Technical report of sea trials conducted by the working group on photo-synthetic radiant energy, Gulf of California, May 1968; sponsored by SCOR, IAPSO, Unesco	1969	WG 15
14.	Fifth report of the joint panel on oceanographic tables and standards, Kiel, 10-12 December 1969; sponsored by Unesco, ICES, SCOR, IAPSO	1970	WG 10
(Note : No. 14 is out of stock)			
15.	Monitoring Life in the Ocean; sponsored by SCOR, ACMRR, UNESCO, IBM/PM	1973	WG 29
16.	Sixth report of the joint panel on oceanographic tables and standards, Kiel, 24-26 January 1973; sponsored by Unesco, ICES, SCOR, IAPSO	1974	WG 10
17.	An intercomparison of some current meters, report on an experiment of Research Vessel Akademik Kurchatov, March-April 1970, by the working group on Current Velocity Measurements; sponsored by SCOR, IAPSO, Unesco	1974	WG 21

An intercomparison of some current meters, II

Report on an experiment
carried out from the
Research Vessel
Akademik Kurchatov,
March - April, 1970,
by the Working Group
on Continuous Current
Velocity Measurements.

sponsored by
SCOR, IAPSO, and Unesco

SCOR Working Group 21

Unesco 1974

TABLE OF CONTENTS

	Page
Abstract	2
Acknowledgements	3
1. Introduction	4
2. Description of Instruments	5
3. <u>Akademik Kurchatov</u> Cruise	13
4. Instrument Performance	19
5. Data Processing	21
a. Preparation and editing	21
b. Standard processing	23
6. Instrument Comparison	25
a. Overall performance	25
b. Sensor response	30
c. Spectral characteristics	40
d. Cross-spectral characteristics	51
7. Conclusions and Recommendations	56
References	60
Appendix: Data Plots	

An intercomparison of some current meters, II.

ABSTRACT

Six types of recording current meter (Alexaev, Bergen, Braincon, Geodyne, LSK and Plessey) were compared during the U.S.S.R. Polygon experiment from the research vessel Akademik Kurchatov. The instruments were set on four moorings arranged in a rough square with approximately 10 km. on a side, centered about 16° 35'N, 32° 50'W for a twelve-day period in late March, 1970. Instruments were arranged in pairs or triads at depths of 50, 200, and 1000 m. One Alexaev instrument was included in each instrument pair or triad.

From the twenty-six records obtained, it was concluded that while the recorded currents were similar in the mean, there were large differences in the response to time-varying currents. Some of these differences are understandable in terms of known instrument characteristics, but two in particular are not. A systematic difference in incremental speed response was noted between Alexaev instruments and other types. The high-frequency energy density for LSK instruments was significantly lower than for other instruments. Further study of these differences is recommended.

Acknowledgements

The working group is indebted to the sponsoring international organizations, SCOR, IAPSO and UNESCO, for initiating the work and contributing essential funds in support of this experiment,

to the Academy of Sciences of the U.S.S.R., for permission to take part in the cruise of the Akademik Kurchatov,

to the parent institutions of its members, for making equipment funds and manpower available without which neither the experiment at sea nor the analysis of the data could have been attempted.

Many people, too numerous to name individually, contributed to the work described here. To all of them, the working group offers its grateful thanks.

K. A. Chekotillo
N. P. Fofonoff
T. Kvinge
B. Shekhvatov
G. Siedler
J. C. Swallow (Chairman)
F. Webster

1. Introduction

Working Group 21 on Continuous Velocity Measurements was established by SCOR in 1966 with the following terms of reference: To design, and propose means for carrying out, an intercomparison at sea of the principal current measuring systems now employed for the continuous recording of current velocity on moored stations.

The Working Group decided that the most effective way of meeting the terms of reference was to carry out an intercomparison experiment at sea. An experiment was done in July, 1967, at Site "D" (39° 20'N, 70°W) using the facilities of the Woods Hole Oceanographic Institution. The results of that experiment have been reported as a UNESCO Technical Paper in Marine Science (SCOR W/G 21, 1969).

In the July, 1967 experiment, five types of recording current meters were compared during an eight-day period. One instrument of each type was installed near 500 m depth on each of three moorings. The instrument types used were: Geodyne film-recording meter, Geodyne tape-recording meter, Bergen meter, Plessey meter, and Hydrowerkstätten Tiefenstrommesser.

It had been planned to include Alexaev current meters in the experiment, but unfortunately it was not possible to do so. In the report of the July, 1967 experiment it was recommended that the work should be completed by including Alexaev current meters in an intercomparison, at least comparing Alexaev instruments with Geodyne instruments.

An opportunity for further intercomparison arose in the Polygon experiment of the U.S.S.R. Academy of Sciences in the Eastern North Atlantic during early 1970. Members of the working group had an opportunity to discuss the

possibility of further intercomparison at the ICES Symposium on Physical Variability in the North Atlantic held at Dublin, Ireland during 25-27 September, 1969 (SCOR, 1969). The Group met and proposed that an intercomparison experiment be made from the Research Vessel Akademik Kurchatov.

The Akademik Kurchatov planned to set out an array of Alexaev current meters as part of the Polygon experiment. It was proposed to set out four other types of current meters (Bergen, Braincon, Geodyne, and Plessey) to be paired with Alexaev current meters for comparison. The arrangements for the experiment were approved and the experiment was carried out aboard the Akademik Kurchatov largely as planned. A fortunate departure from plans was the addition of Warnemunde LSK current meters, four of which were added to the intercomparison array at the suggestion of SCOR.

2. Description of Instruments, Specifications and Calibration Procedures.

Table 2.1 gives details of sensors, dimensions, etc. of each instrument. Further information is given below.

ALEXAEV BPV's.

Two types of Alexaev meter were used in this experiment, one type (the BPV-2) was used at the 50 and 200 m levels and the other type at the 1000 m level. Both types are normally used from a steel bracket clamped rigidly to the mooring wire. The recording system is identical in each type, but the speed sensors differ in that the shallow version has a shielded paddle wheel with four flat blades whereas the other has a 4-cup, unshielded rotor. The rotors are magnetically coupled through the pressure case and drive a

TABLE 2-1
INSTRUMENT CHARACTERISTICS

	Alexaev BPV-2	Alexaev BPV-6	Bergen RCM-4	Braincon 381	Geodyne 850	LSK 801.1	Plessey MO 21
SPEED							
SENSOR:							
Type	shielded flat-bladed paddle wheel	unshielded 4-cup rotor	6-cup Savonius- like rotor	Savonius rotor	Savonius rotor	propeller in tube	propeller
Diameter (cm.)	16.9		10.5	10.5	16	12	11
Height (cm.)	11.5		7	8.6	17		8
Axis	vertical	vertical	vertical	vertical	vertical	horizontal	horizontal
Threshold (cm./sec.)	2.0	2.0	2.6	2.0	1.8	4.0	3.6
Digitizing (cm./sec.)	1.0	1.0	0.3	1.0	0.5	1.3	0.4
Interval							
Sample Duration	3 min.	3 min.	15 min.	14 min.	29 each 2.47 min.	9.8 min.	15 min.
VANE:							
Type	double trailing fin	double trailing fin	trailing fin	trailing fin	freely rotating	crossed trailing fins	crossed trailing fins
Dimensions (cm.)	35 x 49	(see Fig. 3.1)	95 x 37	56 x 61	9.1 x 17.2	32 x 30 32 x 30	40 x 60 30 x 17
Digitizing Interval	5°	5°	0.351°	2°	2.81°	5°	0.351°
Recording Medium	paper strip	paper strip	digital magnetic tape	analog 16 mm. film	digital magnetic tape	waxed paper	digital magnetic tape

gearbox with a reduction ratio of 20:1. The output shaft is connected by a mechanical clutch to a disk with embossed numbers on it at the start of every (3 min) recording cycle. At the end of the cycle a similar concentric embossed disk which acts as a compass card is clamped and a print is made on the paper strip of the embossed numbers adjacent to a reference mark. After the printing the clutch to the speed disk is disengaged and the disk returns to its zero position ready for the next record to be taken.

The speed sensor is mounted at the base of the vertical cylindrical pressure case, the case being aligned in the current by two flat vertical fins. The speed disk is calibrated at the factory at the time of manufacture and there is provision for adjusting the recorder orientation for magnetic variation so that the direction values are given relative to true north. The current meter compasses used in the experiment had damping to reduce oscillations.

BERGEN RCM-4

The instrument has been described by Aanderaa (1964) and by Dahl (1969). The current speed sensor is a Savonius-like rotor mounted on top of the pressure case. The revolutions of the rotor are transferred by a magnetic coupling through the pressure case to a 6000:1 gearbox, the output shaft of which is connected to a precision potentiometer. The position of the wiper of the potentiometer is sensed once every 15 minutes by a bridge circuit and the resistance value is converted to a 10-bit binary number by an electromechanical encoder. The speed value is computed by taking the difference in successive encoder values. The instrument is aligned in the current by a flat vertical fin and the current direction

is measured by finding the orientation of the pressure case relative to magnetic north once every 15 minutes. The compass consists of a pair of bar magnets attached to an electrical contact. This is clamped electromagnetically once every 15 minutes so that the contact touches a potentiometer. The resistance value is measured in the same way as for the speed. The compass is a sealed, oil-filled unit.

The time series is made up of the mean of two successive speed values combined with the direction recorded at the end of the first of the two speed encoding periods. In this way, the direction value is taken at the midpoint of the corresponding speed value.

In each cycle the water temperature, measured by a thermistor, and a reference number are also recorded.

Each instrument used in the experiment had been calibrated by towing in a tank and by measuring the encoded values of direction for 10° increments in orientation. Each instrument had a linear calibration line.

The instruments were standard production models with the exception of the clocks.

The current meter is normally mounted directly in the mooring wire and is pivoted at the centre of the suspension bar with freedom to tilt up to 30° from the horizontal in any orientation. In the experiment described here the Bergen instruments were suspended by short wire straps from large brackets clamped rigidly to the mooring wire (Fig 3-1).

BRAINCON 381

Current speed is measured by a Savonius rotor of 11 cm diameter turning on a vertical axis. Rotor turns are counted over a 15-minute interval. The output is in the form of an arc on film; the length of the arc is proportional to the

number of rotor revolutions. The arc length, θ_n , assigned to the n^{th} film frame was calculated from the starting (S) and ending (E) positions of sequential frames by

$$\theta_n = \frac{(S_n - S_{n+1}) + (E_{n-1} - E_n)}{2} .$$

This procedure eliminates the need to know the arc length of the recording system itself or the film advance time. The rotor calibration data supplied by the manufacturer in April, 1970 was fitted at Bedford Institute by the equation:

$$V = .4169R + 4.3312 - 3.356e^{-.0356R}$$

where V = speed, in cm/sec
and

$$R = \frac{\theta \cdot G}{\Delta t \times 360} \text{ rev. per minute,}$$

where G = gear box reduction factor (7200 for this experiment),
and Δt = sampling interval (15 min here).

The direction is measured as the orientation of the pressure case relative to magnetic north. The pressure case is aligned by a flat vertical fin 61 cm high and 56 cm long. The direction is again recorded as an arc on film, the density of the arc at each angle varying according to the frequency of occurrence of values at that angle. Non-linearities in the compass calibration were taken into account.

The film advance is controlled by an Accutron timer. Time is recorded on the film by photographing an independent watch face (this is not standard in Braincon instruments).

Instrument tilt is measured, but for the records used here, the tilt values are below the measurement threshold of 3°.

GEODYNE 850

The instrument is housed in a cylindrical case about 1.8 m long. At the lower end are a Savonius rotor of 16 cm diameter turning on a vertical axis and a vane turning on a vertical axis.

The sampling procedure is to obtain a set of 29 samples of speed and direction during 2.5 minutes once every 15 minutes. For speed, sixteen pulses are generated by each turn of the rotor and these pulses are counted over the nominal 5-second intervals. Speed is derived from the rotor pulses using the formula:

$$\text{Speed (mm/sec)} = 379.4 \times \frac{\text{Rotor count}}{16 \times \Delta t} + 17.9$$

where Δt = time of count in seconds. This formula is derived from the calibration curve of Fofonoff and Ercan (1967). The final values used as 15-minute samples are obtained as vector averages over the 2½-minute burst of samples.

The direction is measured by taking the sum of the compass and vane readings at five-second intervals. The compass gives the orientation of the case with respect to the earth's magnetic field. Since the instrument case is symmetric, the case is free to rotate. Both compass and vane are encoded in seven-level-binary so that 360° corresponds to 128 divisions, and the resolution is about 2.81°.

A time word derived from a crystal clock is written on the magnetic tape with every group of samples. The same clock paces the stepping motor for the tape advance. The worst-case clock inaccuracy does not exceed one second per day.

LSK 801.1

The LSK current meter is mounted directly on the mooring line and has a horizontal case 1.4 m long and about 11 cm in diameter with a propeller on the forward end and both vertical and horizontal fins, each about 30cm square, on the rearward end.

The propeller turns are counted over a 9.8-minute interval. The values are inscribed on a waxed-paper tape with a 4 cm scale width corresponding to 200 cm/sec. Speed resolution is about 1.3 cm/sec with a rotor threshold of 4 cm/sec.

A compass reading of the case orientation is taken every 4.9 minutes. Directions are given in 5° increments, and the waxed paper tape record is 1.8 cm wide corresponding to 360°.

A timing pulse is put on the record every four hours by a clock with a nominal error of less than 10 minutes/month. This clock also drives the waxed paper take-up spool.

PLESSEY M021

The Plessey recording current meter design is derived from the Bergen meter and employs a similar recording system; the mechanical design, however, differs considerably.

The Plessey meter uses a propeller as a speed sensor, and the pressure case is mounted horizontally and is suspended from a bracket clamped to the mooring wire. Unlike the Alexaev brackets those of the Plessey meter are free to rotate about the wire. The pressure case is not restrained to remain horizontal but is stabilized by small horizontal trimming surfaces on the fin and by a weight. The registration both of speed and direction are identical with that of the Bergen meter, but in the instruments used in this experiment the additional temperature channel was not used.

3. Akademik Kurchatov Cruise

In addition to Dr. K. A. Chekotillo of the Institute of Oceanology, U.S.S.R. Academy of Sciences, other scientists participating in the experiment aboard the Soviet Research vessel Akademik Kurchatov were:

- E. Francke, Institut für Meereskunde, G.D.R.
- W. J. Gould, National Institute of Oceanography, U. K.
- R. Heinmiller, Woods Hole Oceanographic Institution, U.S.A.
- D. J. Lawrence, Bedford Institute, Canada
- G. Plüschke, Institut für Meereskunde, G.D.R.
- C. K. Ross, Bedford Institute, Canada
- W. Zenk, Institut für Meereskunde, F.R.G.

The visiting scientists with their equipment joined the Akademik Kurchatov at Warnemünde, G.D.R., and Dover, U. K., in early March, 1970. The ship was on her 7th Oceanographic Cruise, under the leadership of Dr. G. N. Ivanov-Frantzkevich. Mooring operations were the responsibility of Dr. Chekotillo.

During the passage to the area of the polygon experiment, west of the Cape Verde Islands, the instruments were prepared for incorporation in the array. It is the practice on the Soviet moorings to have a continuous wire with the current meters suspended from brackets clamped to the wire. This method of suspension was used for all of the instruments. Brackets for the Bergen meters had been made at N.I.O., and the LSK and Plessey instruments could be suspended in their normal manner. All the other instruments were hung from standard or modified Alexaev brackets. Weights of 15 kg. were hung beneath the Bergen and Braincon instruments in order to stabilize them during lowering. A stand-off bar was mounted between the lower end of the Geodyne meters and the mooring wire in order to stop chafing (Fig. 3.1).

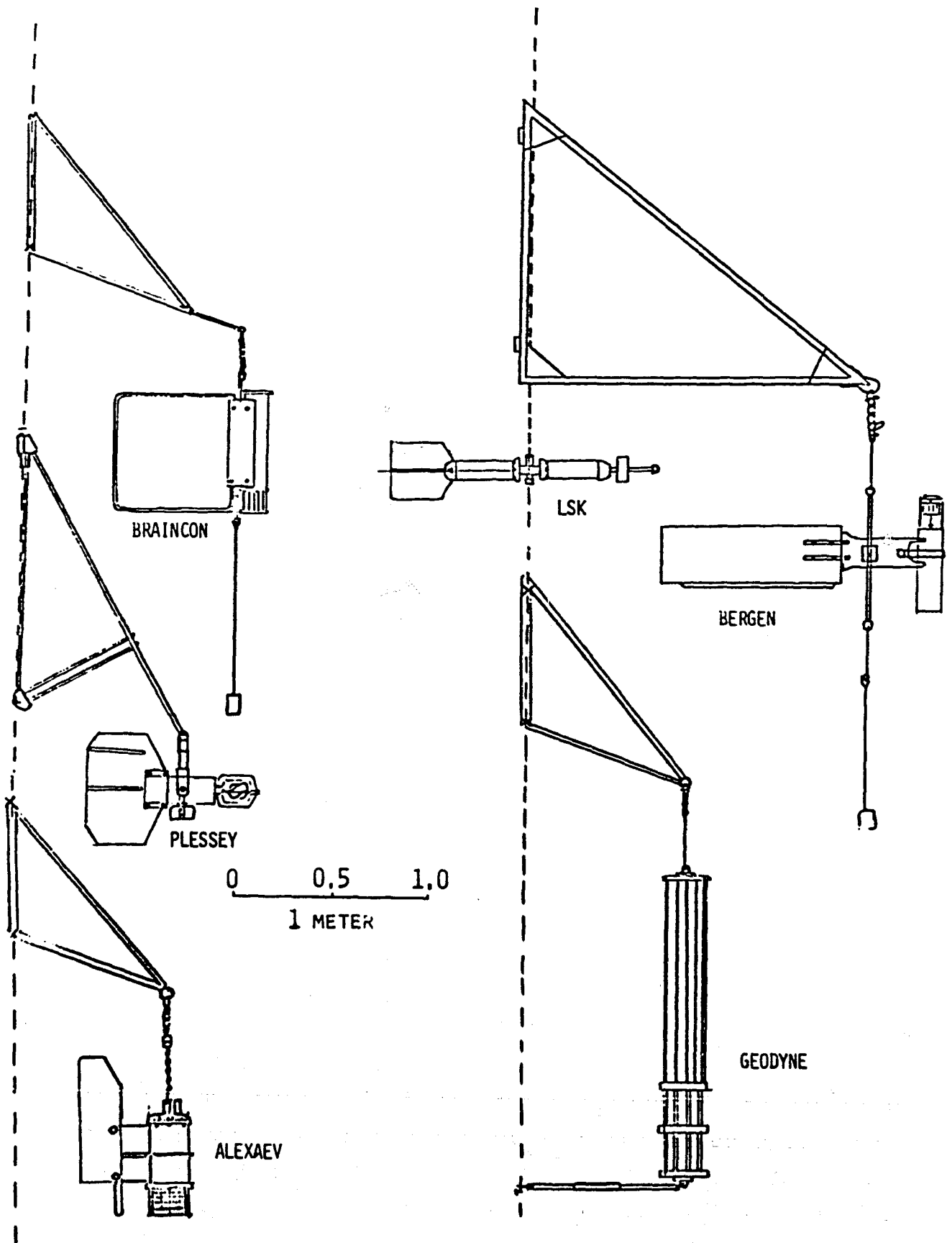

Figure 3-1 Sketch of instruments used in the intercomparison experiment showing means of mounting and relative instrument configurations.

For convenience during the launching operation and for increased safety of the instruments, the proposed depths of 25, 100 and 1000 m for the intercomparison were changed to 50, 200 and 1000 m. At each of these depths one of the visiting meters was paired with an Alexaev meter. One of the four LSK instruments was paired with one of each of the visiting instruments (Table 3.1). In each of the groupings the meters were positioned to give a 4 m vertical separation of speed sensors.

The Alexaev BPV meters were transferred at sea from the Research Vessel Dmitri Mendeleev which had brought them to the area earlier.

The moorings were laid on 20-21 March, 1970 at the corners of a rough square, having sides about 10-15 km (Figure 3.2) centered on $16^{\circ} 33'N$, $32^{\circ} 49'W$. All moorings had surface buoyancy. The wire had a scope of about 1% and was made up from differing diameters between 11.5 and 5.3 mm. During the 12-day period of the intercomparison the Akademik Kurchatov was engaged in other oceanographic work within the area of the polygon and so it was not possible to keep a constant check on the moorings. When the buoys were recovered it was found that moorings 3 and 4 had suffered some damage. A steel tube had fractured in each of the surface buoys and in the case of buoy 4 this had resulted in its floating upside down with the mooring attached by a pick-up wire. Fortunately all the moorings and instruments were recovered intact. On April 7th, the Akademik Kurchatov berthed in Monrovia, Liberia where the visiting scientists and their equipment left the ship.

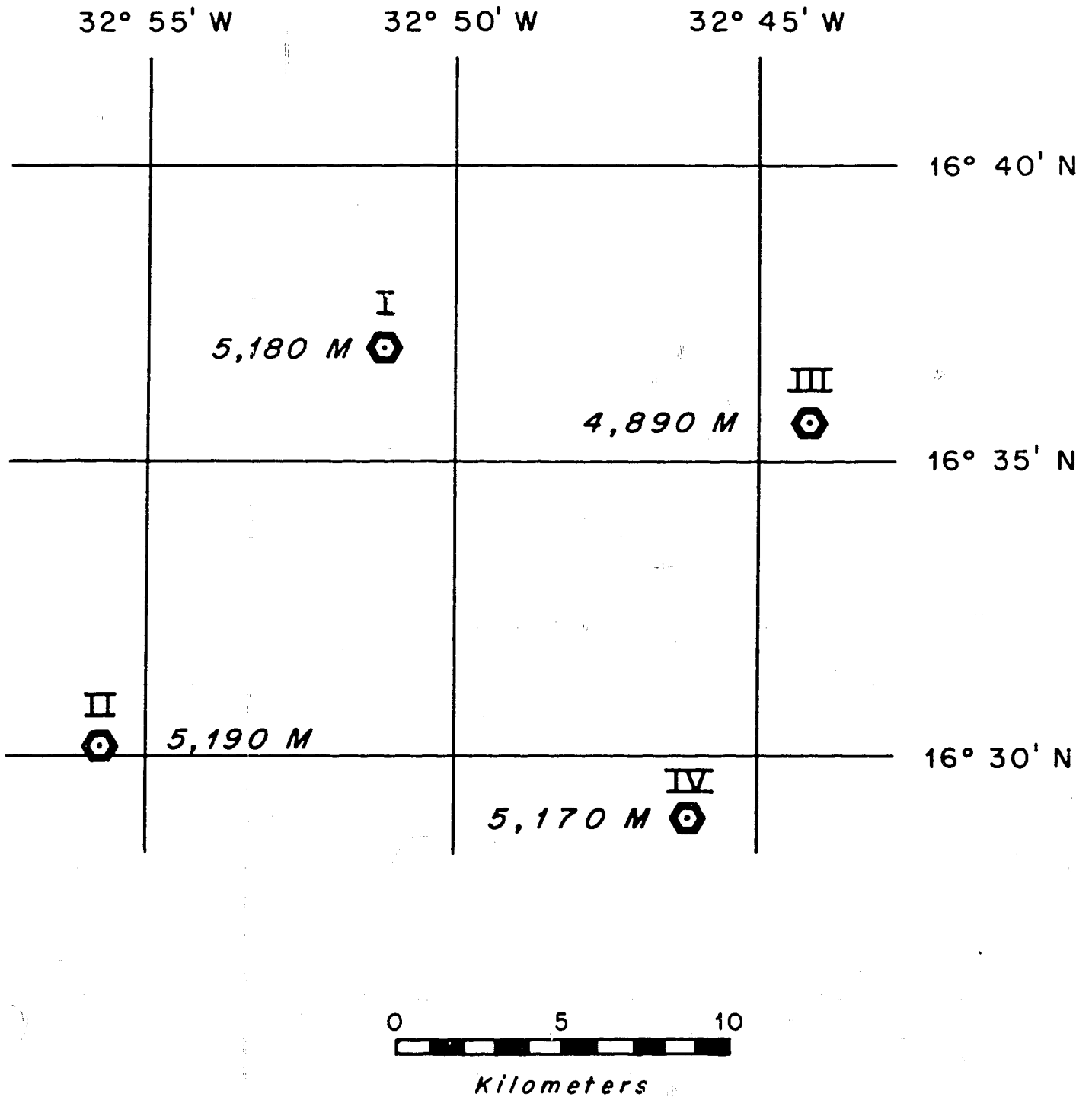

Figure 3-2 Chart of intercomparison experiment showing relative position of moorings.

Copies of all data obtained were sent to the Woods Hole Oceanographic Institution for processing by the end of September, 1970. K. A. Chekotillo (U.S.S.R.) participated in a detailed analysis of the data from mid-October, 1970 to February, 1971. For a two-week period in December, 1970 W. J. Gould (U.K.) and D. J. Lawrence (Canada) joined in a working session to draft the outline and most of the substance of this report. The draft report was then circulated for comment to other members of the Working Group. The final form of the report was agreed upon at a meeting of the Working Group during the 15th General Assembly of the I.U.G.G. in Moscow in August, 1971.

At the Woods Hole Oceanographic Institution, the data analysis was supervised by F. Webster. J. Maltais prepared a number of special computer programs for the purposes of the analysis. S. Tarbell and C. Harlow carried out the basic processing and prepared many of the figures.

4. Instrument Performance

The instruments are reviewed below by type. The data files are referred to by their numbers. The numbering system adopted is as follows:

The first digit refers to the mooring number. The second digit refers to the position of the instrument on the mooring, counting down from the top. All data files are prefixed by the letters "AK".

			Time error on recovery (sec.)
(1) Alexaev (ALX)			
AK	12	Ran for only 6 days	uncertain
AK	15	Performed normally	+ 360
AK	17	Performed normally	+ 360
AK	22	Performed normally	- 120
AK	24	Ran for only 4 days	uncertain
AK	27	Performed normally	- 60
AK	32	Performed normally	+ 180
AK	34	Performed normally	+ 180
AK	36	No data	
AK	41	Ran for only 4 days; abnormal decrease of speeds	uncertain
AK	44	Performed normally	+ 120
AK	46	Performed normally	- 60
(2) Bergen (BER)			
AK	11	Performed normally	+ 20
AK	26	Performed normally	+ 60
AK	35	Performed normally (Replaced rotor during launch)	+ 75
(3) Braincon (BRA)			
AK	23	Performed normally	- 10
AK	33	Data not readable. Film cartridge misaligned	
AK	47	Performed normally	+ 57

Time error on recovery
(sec.)

(4) Geodyne (GEO)

AK 14	Performed normally	- 6
AK 37	Performed normally	- 9
AK 42	Performed normally	- 5

(5) LSK

AK 13	One of the 8 propeller blades was missing on recovery. Considerable wear of meter case against wire clamp.	uncertain
AK 25	Performed normally	+ 80
AK 31	Performed normally	+ 505
AK 43	Performed normally	+ 120

(6) Plessey (PLE)

AK 16	Part of tail fin was missing on recovery. Compass stuck almost entire time	- 7
AK 21	Compass stuck for 30 hours	- 167
AK 45	Compass stuck for last 6 days	- 326

The external appearance of the instruments was good on recovery. Corrosion was generally slight. Goose barnacles (lepas) were growing on the 50-meter instruments but did not appear to affect their operation. All rotors and propellers were turning freely.

5. Data Processing

(a) Preparation and Editing

The records from all of the instruments were processed at their "home laboratories" by the procedures normally employed by each of the participants. An outline of the preliminary processing is given below.

ALEXAEV

The speed and direction values were read from the printed paper tape and entered onto special forms aboard the Akademik Kurchatov immediately after instrument retrieval. The numbers were checked for accuracy at the Institute of Oceanology, U.S.S.R. Academy of Sciences in Moscow; the data were not edited. A summary of the data was typed, checked, and mailed to Woods Hole.

BERGEN & PLESSEY

The 1/4" magnetic tapes from the Bergen instruments were read in Bergen, Norway by the manufacturer. The Plessey records were read at the Fisheries laboratory, Lowestoft, U. K. Data from both types of instruments thereafter were processed at the National Institute of Oceanography, U. K.

The processing procedure consisted of the application of calibration equations to the digital values of speed, direction and temperature received from the tape readings. Any obvious errors from readings taken in the rotor potentiometer dead-space were replaced by a linear interpolation. The edited data were sent on computer magnetic tape to Woods Hole for further processing.

BRAINCON

The Braincon films were processed and read at the Bedford Institute. The directions were taken as those indicated by the densest part of the exposed arc on each film frame. The arc lengths were often very great, indicating a large spread of directions. In one of the records several frames were exposed without the film moving on. These data were identified by the watch face and were corrected by linear interpolation.

A program was used to reveal gross errors introduced in the film reading process and the data were edited. The calibration curve used to convert the arc lengths to speeds was derived at the Bedford Institute, Canada, from data supplied by the manufacturer. The first set of data sent to Woods Hole was calibrated using an incorrect curve fit. The curve was re-fitted and a second computer magnetic tape was sent to Woods Hole with corrected speed. In the data processing the corrected Braincon data are identified with the suffix "A" (e.g., AK23A, AK47A).

GEODYNE

The Geodyne data were first translated at Woods Hole from the instrument tape cartridge onto a 7-track computer magnetic tape. This in turn was converted, and speed and direction were put into final form on a 9-track computer tape in the standard W.H.O.I. tape format (Maltais, 1969).

The data were not edited.

Geodyne directions were corrected to compensate for non-linearities in the compass calibration. When first applied, the compensation was used with the opposite sign to the correct one. After the error was found, the data were corrected by applying the non-linear compensation with the proper sign. The corrected Geodyne data are identified with the suffix "A" (e.g., AK4A, AK37A, AK42A).

LSK

The LSK samples were taken every 4.9 minutes for direction and every 9.8 minutes for propeller count. The waxed paper tape is driven by rotating the take-up spool at a constant speed, so that the paper advance changes from 91 mm./day to 125 mm./day. The inscribed paper record was smoothed by drawing a line through the end points of the pulses and then was automatically digitized at constant distances. The resulting "raw" series of values had a sample rate that varied between about 6 and 7 minutes. The 15-minute samples were obtained by taking the numerical average of the raw values between +7 and -7 minutes from the nominal sample time.

Listings of the raw and 15-minute samples were sent to Woods Hole. A few bad values were edited from the series at Woods Hole.

(b) Standard Processing

Following the preliminary processing, further data analysis was carried out on each record at the Woods Hole Oceanographic Institution. A standard set of computations were performed to obtain comparable derived results for each record.

A set of plots resulting from the standard processing are presented in the Appendix to this report (published as a separate volume). In this volume, progressive vector diagrams, vector distribution plots, and some spectral plots are presented. In the Appendix, time histograms, cartesian components, progressive vector diagrams, spectra, and statistics (STATS) are presented. Those plots are described there.

For the plots given in this volume, descriptions follow:

PROGRESSIVE VECTOR DIAGRAM

Progressive displacements are computed using cartesian (east and North) components derived from the original 15-minute speed and direction values. The beginning of the

plot is marked with an asterisk (*). At the beginning of each day the position is marked with a cross (+) and the date is printed alongside. Note that, although a plot of this kind has the appearance of a particle trajectory, it is not. It is a virtual displacement computed by integrating a time series of vector measurements at a single point.

VECTOR DISTRIBUTION PLOT

The East and North components of each 15-minute value are plotted against each other. The resulting "scatter plot" is useful for identifying systematic instrument performance characteristics. Individual points are not generally identifiable. Where possible, Vector Distribution Plots have been computed over the standard time interval. Shorter records have been used but are flagged with a diagonal line.

SPECTRA

The spectral analysis program uses the Fast Fourier Transform algorithm over the 1024 15-minute values of the standard time interval. East and North components are separately analysed, then the resulting spectral estimates are averaged to give an estimate of horizontal kinetic energy in each frequency band.

With 1024 data points, a raw spectrum is first computed over 512 frequency bands. This has been then averaged over three adjacent frequency bands to provide increased stability of estimates. The final spectral estimates shown have a bandwidth of 0.0117 cycles per hour (cph) and 12 degrees of freedom.

6. Instrument Comparison

(a) Overall performance

METHOD OF COMPARISON

The results presented in this chapter begin with net properties determined over the duration of the experiment and go on to time-variable properties of progressively shorter scale. It is not possible to present these results without occasional reference to their interpretation.

As an introduction to the presentation of comparative instrument performance, Table 6-1 gives a brief summary of data quality.

In order to standardize the comparison between instruments all estimates involving averaging were made over a uniform time interval from 0000 hrs., GMT, 22 March, 1970
to 1559 hrs., GMT, 1 April, 1970.

This interval covers nearly the entire period that is common to all full data series and has the advantage that its length, with 1024 15-minute samples, is convenient for spectral analysis.

Table 6-2 summarizes speed and direction of the vector mean current over the uniform time interval. Only time series in which both direction and speed values are reliable over the uniform time interval are included. An exception is AK21(PL) in which the compass stuck for about 30 hours. The mean current for AK21 is included parenthetically in Table 6-2.

MOORING I		MOORING II		MOORING III		MOORING IV		DEPTH (m.)
AK11	BER	AK21	PLE	AK31	LSK			46
		Compass stuck for 30 hours						
AK12	ALX	AK22	ALX	AK32	ALX	AK41	ALX	50
Short record 6 days						4-day record Abnormal decrease of speeds		
				AK33	BRA	AK42	GEO	54
AK13	LSK			No data				192
Time base uncertainties								
AK14	GEO	AK23	BRA			AK43	LSK	196
AK15	ALX	AK24	ALX	AK34	ALX	AK44	ALX	200
		Short record 4 days						
				AK35	BER	AK45	PLE	204
		AK25	LSK			Compass stuck last 6 days		992
AK16	PLE	AK26	BER					996
Compass stuck for nearly entire record								
AK17	ALX	AK27	ALX	AK36	ALX	AK46	ALX	1000
				No data				
				AK37	GEO	AK47	BRA	1004

Table 6-1 Data Quality

MOORING I		MOORING II		MOORING III		MOORING IV		DEPTH (m.)
AK11 15.8, 308°	BER	AK21 (18.8, 308°)	PLE	AK31 11.3, 294°	LSK			46
AK12 _____	ALX	AK22 19.4, 306°	ALX	AK32 9.7, 300°	ALX	AK41 _____	ALX	50
AK13 7.9, 326°	LSK			AK33 _____	BRA	AK42A 15.6, 325°	GEO	54
AK14 A 9.6, 324°	GEO	AK23A 8.3, 302°	BRA			AK43 10.4, 305°	LSK	196
AK15 11.1, 324°	ALX	AK24 _____	ALX	AK34 11.2, 320°	ALX	AK44 13.3, 303°	ALX	200
		AK25 3.8, 273°	LSK	AK35 8.9, 325°	BER	AK45 _____	PLE	204
AK16 _____	PLE	AK26 7.6, 294°	BER					996
AK17 3.2, 334°	ALX	AK27 4.6, 293°	ALX	AK36 _____	ALX	AK46 8.6, 301°	ALX	1000
				AK37A 4.5, 333°	GEO	AK47 A 7.1, 299°	BRA	1004

TABLE 6-2
VECTOR MEAN CURRENT: CM/SEC

NET CURRENT DIRECTION

With one exception the difference in net direction between instruments in pairs and triplets is less than 6° . This is not much larger than the quantizing interval for direction in at least one member of each triplet or pair. The exception is AK25(LSK) which is about 20° less than the other two instruments at its depth. Because of probable differences in the pattern of currents over the array, comparisons between instruments on different moorings may not be valid. The net directions among all instruments range from 273° to 338° , making a total spread of 65° .

NET CURRENT AMPLITUDE

The net current amplitudes, summarized in Table 6-2, shows differences within each pair or triplet extending from 0.6 to 3.8 cm/sec. A bias in net current amplitude associated with any of the instruments is difficult to detect.

PROGRESSIVE VECTOR DIAGRAMS

The net current can be considered as the velocity associated with the displacement vector drawn directly from the beginning to the end of a progressive vector diagram. The progressive vector diagrams in Fig. 6-1 show that the current is not constant either in space over the array or in time at each point. The many variations associated with higher-frequency processes are discussed in the next section.

CURRENT VARIABILITY

A study of the deviations of the currents from the net or mean values can provide much insight into the comparative response of the instruments and is the basis of the sections which follow. The vector variance of each series

Figure 6-1 PROGRESSIVE VECTOR DIAGRAMS

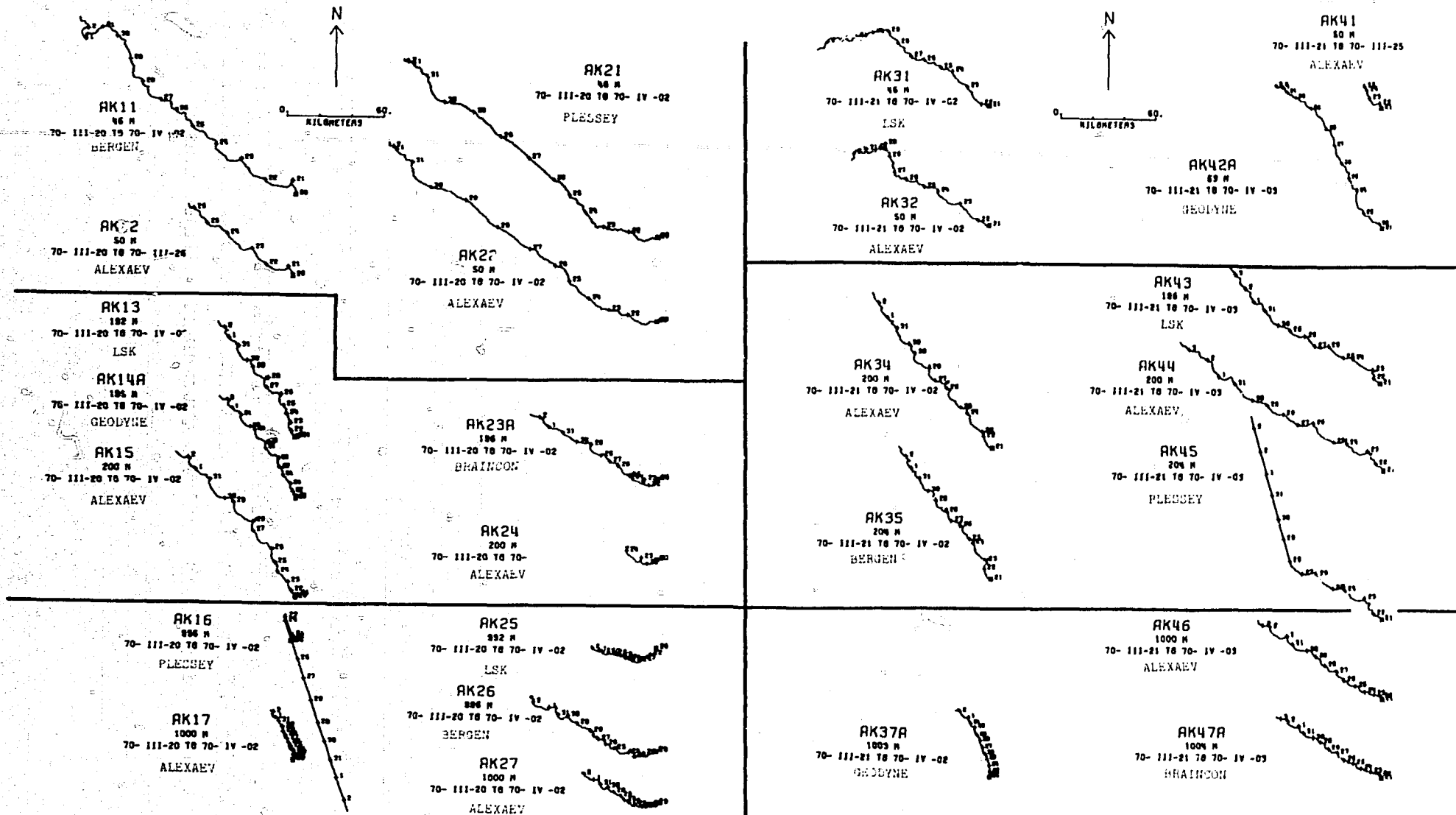

over the standard time interval is given in Table 6-3. An understanding of the differences between the variances of paired instruments can be aided by examining the patterns of current variability.

Figure 6-2 shows a set of vector distribution plots corresponding to the 26 data records available. In these plots, each separate vector measurement is plotted as one point with the north component as ordinate and east component as abscissa. The ensemble of points shows the range of variability of the velocity vectors. The plots use the data over the uniform time interval with the exception of the three short records: AK12(ALX), AK24(ALX), and AK41(ALX); for these, all data available were used, and the plots are flagged with a diagonal line.

The time histogram plots given in the Appendix to this report are valuable for examining the scatter of speed in direction as it varies with time. Since long-term averages are not used, it is possible to use the time histograms for those records that are short or have partial sensor failure. They are particularly useful, for example, for showing the extent and character of compass failure on the Plessey instrument.

The dominant differences in these plots are related to instrument performance. A detailed discussion of the apparent instrumental differences is presented in the following sections.

(b) Sensor response

The vector distribution and time histogram plots reveal large differences in the range of speeds registered on some pairs and triplets of instruments. Since the vertical

MOORING I		MOORING II		MOORING III		MOORING IV		DEPTH (m.)
AK11 204	BER	AK21 162	PLE	AK31 80	LSK			46
AK12	ALX	AK22 168	ALX	AK32 121	ALX	AK41	ALX	50
AK13 53	LSK			AK33	BRA	AK42 A 58	GEO	54
AK14A 44	GEO	AK23 A 46	BRA			AK43 60	LSK	192
AK15 117	ALX	AK24	ALX	AK34 140	ALX	AK44 112	ALX	196
		AK25 31	LSK	AK35 87	BER	AK45 82	PLE	200
AK16 78	PLE	AK26 107	BER					204
AK17 25	ALX	AK27 31	ALX	AK36	ALX	AK46 46	ALX	992
				AK37A 20	GEO	AK47A 19	BRA	996

Table 6-3 Vector variance (CM²/SEC²)

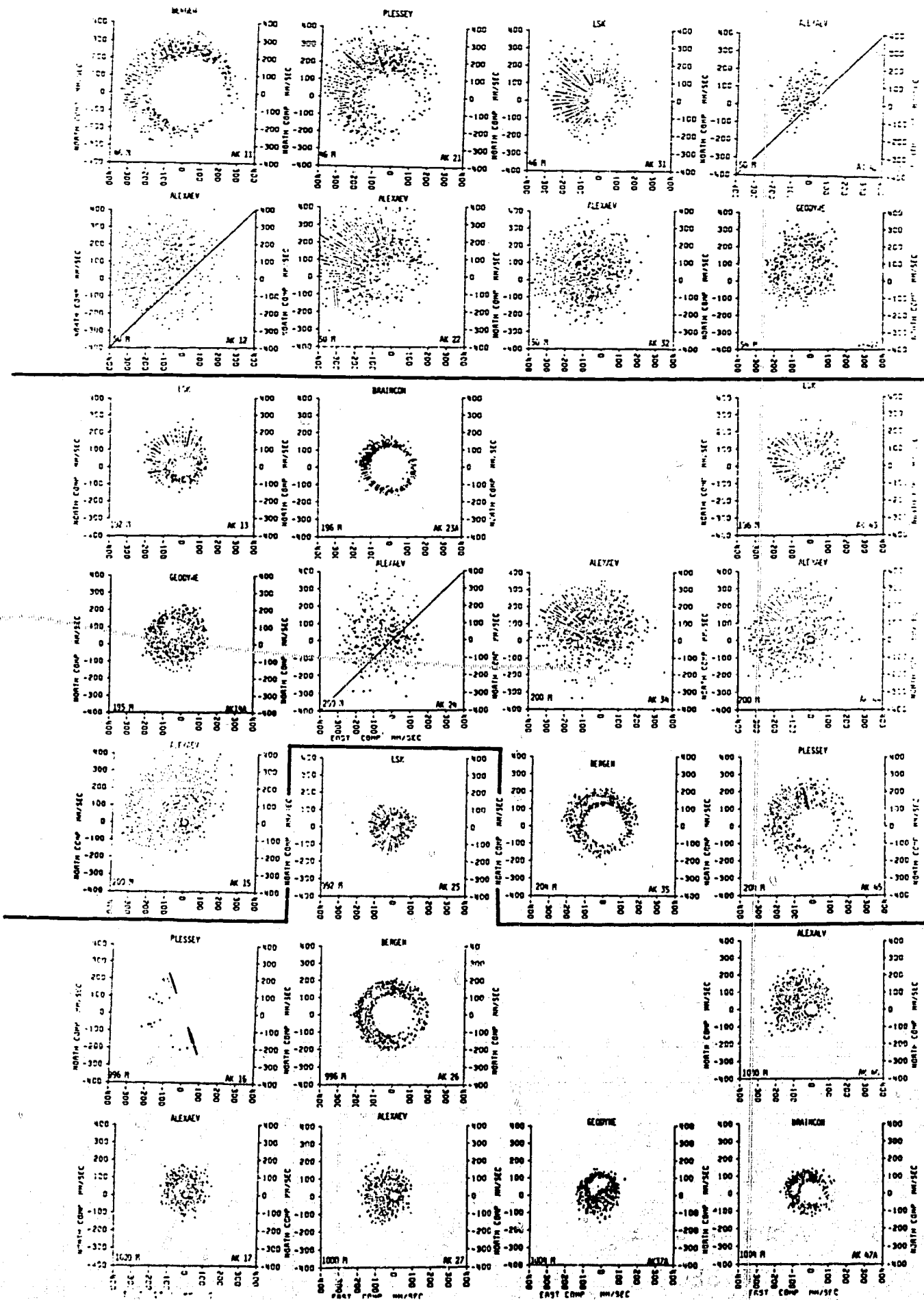

Figure 6-2 Vector distribution plots.

separation of the speed sensors in each pair was only 4 m. such large differences, in the light of past experience of vertical shears, seem unlikely to be explainable in terms of variability within the ocean. We must look for an explanation in terms of the response of the speed sensors themselves and in terms of the means of mounting the current meters on the mooring.

The most striking feature is the absence of low speed values on all the records from the Plessey, Bergen and Braincon instruments. The minimum speed registered on each of these instruments is dependent on depth, being highest near the surface and decreasing with depth. This is clearly illustrated by the vector distribution plots shown in Fig. 6-2. In these plots the lack of low speed values is characterised by a "hole" in the center of the plots. None of the Geodyne records show any loss of low speeds. Only in one case, at 200 m. (AK22), does a shallow Alexaev show a "hole". In the case of the LSK meters there are holes for records AK13, 31, and 43. As similar plots were not shown in the report of the first intercomparison experiment (SCOR W/G 21, 1969), Fig. 6-2a gives vector distribution plots of the data of this earlier experiment for comparison. Here, no holes with a radius exceeding the threshold speed can be seen at any instrument.

The hole in the vector distribution plots can arise in two ways. First, from an inappropriate combination of speed and direction sampling rates, and secondly from a mismatch in response of the speed and direction sensors themselves. These effects become more pronounced in the presence of high-frequency, high-wavenumber fluctuations.

The data from the Geodyne meters show no holes in the vector distribution plots at any depth. This can be explained by the sampling regime used in this meter which takes 29 samples of speed and direction at 5-second intervals for $2\frac{1}{2}$ minutes and then sums these vectorially. The vane is small and orients independent of the pressure case. It is thus free to respond to high frequencies. It is possible to have

a high rotor speed throughout the recording cycle but to have sufficient variability in directions to give a zero vector summation.

The sampling procedure used in some of the other instruments was simulated using Geodyne data by taking a scalar mean speed from the set of 29 values and combining this with a single direction derived from the sum of sines and cosines of the 29 directions. The resulting vector distribution plots are shown in Fig. 6-3 (Geodyne Q vector distribution plots). A comparison of these with the originals (Fig. 6-2) illustrates the consequences of integrating rotor counts in the presence of high-frequency fluctuations.

The size of the hole depends partly on the behavior of the speed sensors themselves, as well as on the sampling regime. In the LSK meter, the speed sensor is a propeller made up of flat, angled blades on the ends of radial spokes, and is mounted in a short tube. It has little response to components of flow at right angles to its axis and is free to reverse if the axial flow reverses. With such a sensor, fluctuations of current on a scale too small to cause significant changes of vane orientation would tend to be integrated vectorially and might produce little net effect. In contrast, the Savonius rotor of the Braincon and the rotor of the Bergen meter have an omnidirectional response, and tend to indicate the total length of water going past the rotor instead of only the component in the vane direction. This may account for the relatively small size of the LSK "hole" compared to those of the Bergen and Braincon records. The Plessey propeller is capable of some response to flow at right angles to its axis and is shielded from reversals

249

250

251

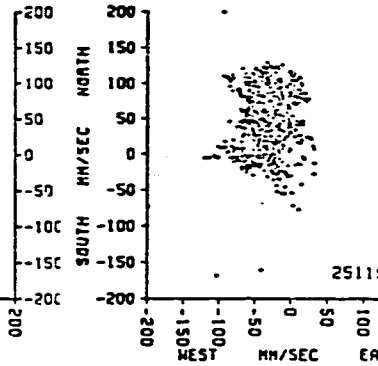
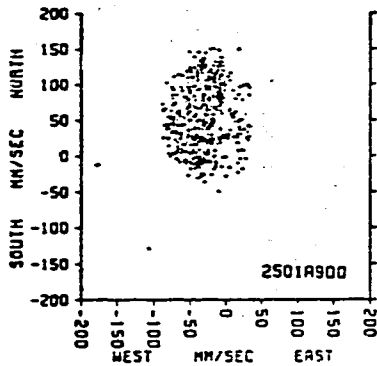
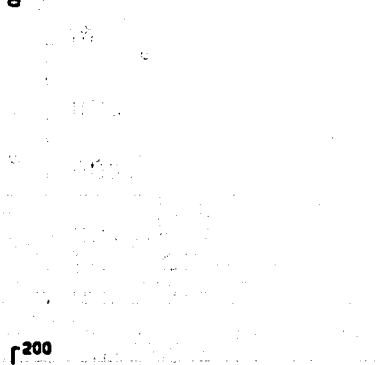
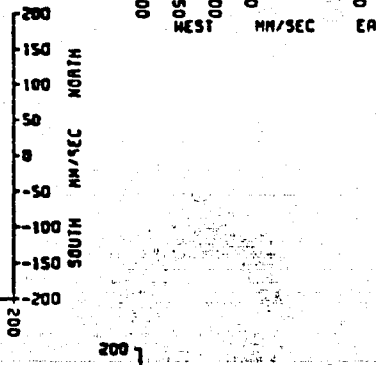
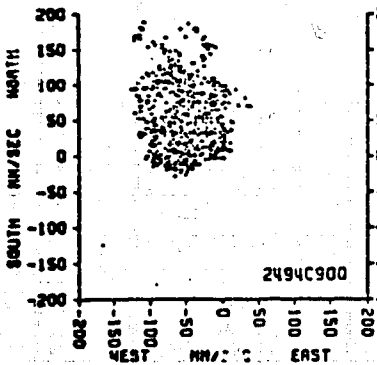
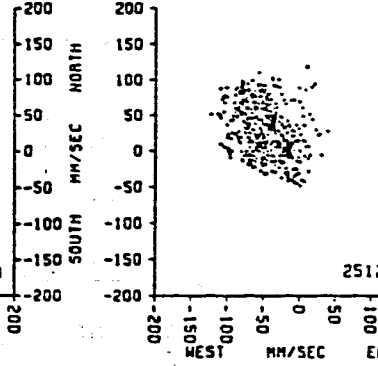
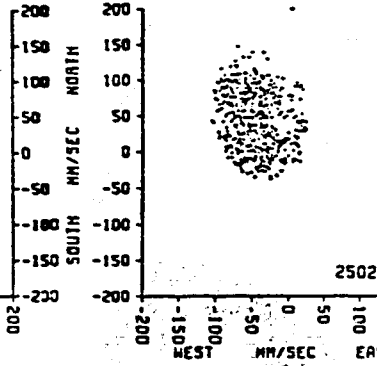
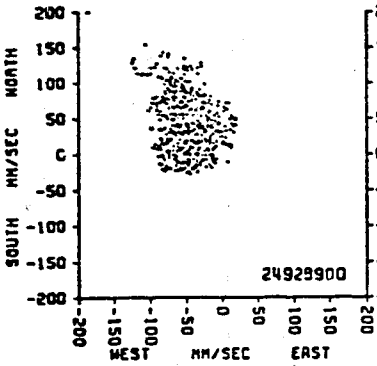

GEODYNE TAPE

BERGEN

PLESSEY

HYDROWERKSTATTEN

GEODYNE FILM

VECTOR DISTRIBUTION PLOTS FOR FIRST INTERCOMPARISON EXPERIMENT
FIGURE 6-2A

AK42AQ
53 M

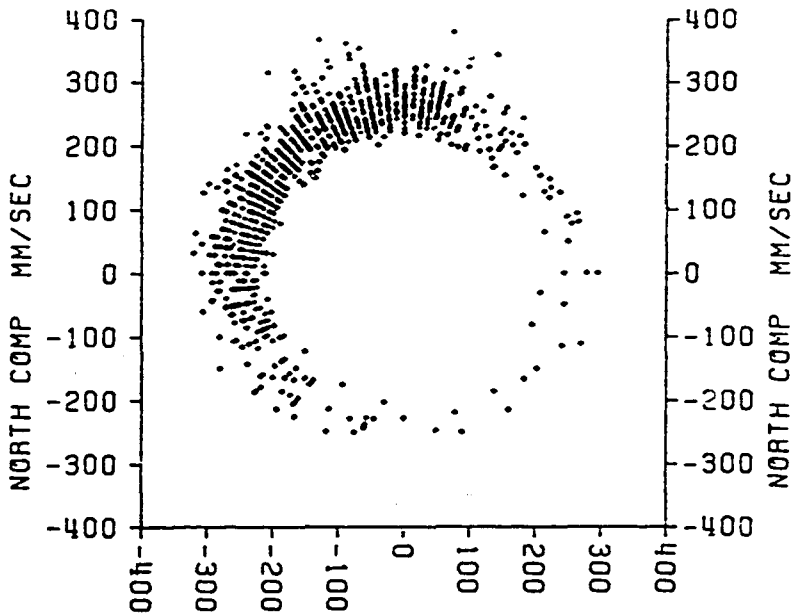

AK14AQ
195 M

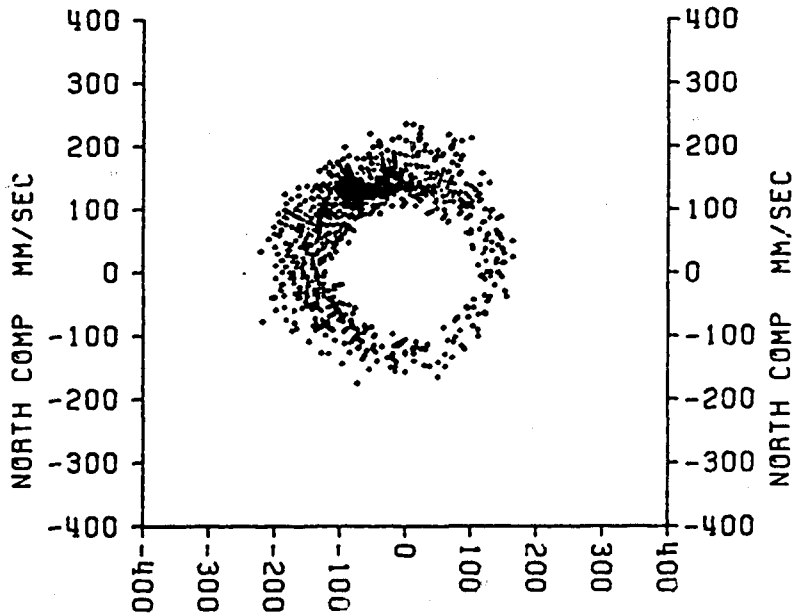

AK37AQ
1003 M

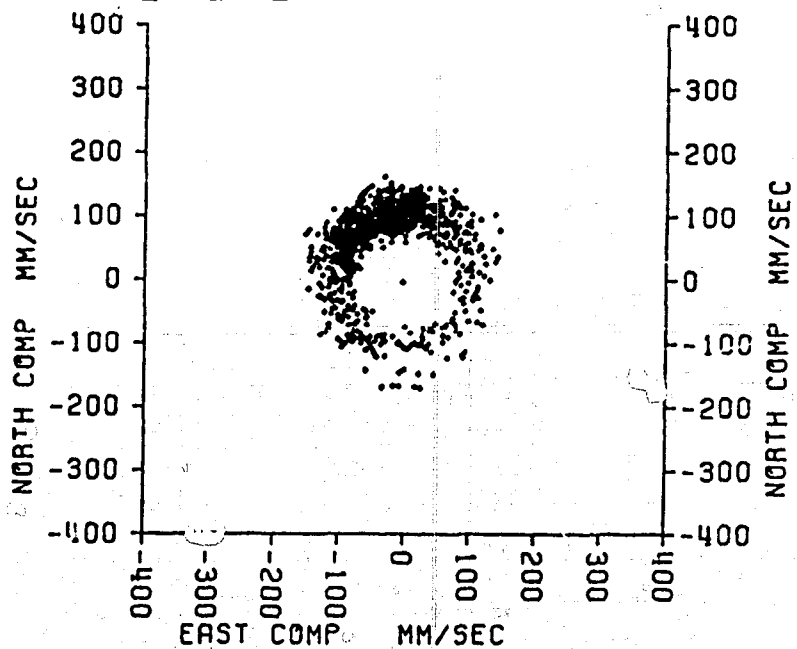

Figure 6-3 Vector distribution plots for Geodyne instruments using scalar speed over 2½ minute interval instead of vector average (Q-version Geodyne).

of flow by its pressure case. Its response to small-scale fluctuations might be expected to be intermediate between that of the LSK and the Bergen. This can be seen in the vector distribution plots, Fig. 6-2, records AK11, 21, 31. The response of the Alexaev speed sensors to small-scale fluctuations is not known, but the records from those instruments show no significant lack of low speeds.

A way of directly comparing the speeds on pairs and triplets of instruments is to plot the speed on one instrument against that of the other. This has been done and the resulting plots are shown in Fig. 6-4. A certain amount of distortion is introduced by the lack of low speeds in some of the records. In spite of this, few of the plots have a distribution of points centered on the 45° line. The only ones which do are AK45/43 (PLE/LSK), AK14A/13 (GEO/LSK), AK25/27 (LSK/ALX).

In comparisons with all other instruments, there is a tendency for the Alexaev meter to read high at high speeds and low at low speeds (or for all the other instruments to read the reverse). The LSK instrument is the only one which is paired with meters other than the Alexaev. Its speed performance appears to be consistent with both Geodyne and Plessey instruments.

The discrepancy in speeds between Geodyne and Alexaev instruments can be examined further by plotting their speed ratio against the variance derived from the directions in the bursts of the Geodyne record. The pair of records AK14A(GEO) and AK15 (ALX) were matched and a plot was made of speed ratio vs. Geodyne direction variance (Fig. 6-5). It shows a tendency for the ratio to be low at high variance and greater than unity at low variance. An extrapolation to zero variance (the analog to towing the instruments in a tank) gives a speed ratio of 1.5 .

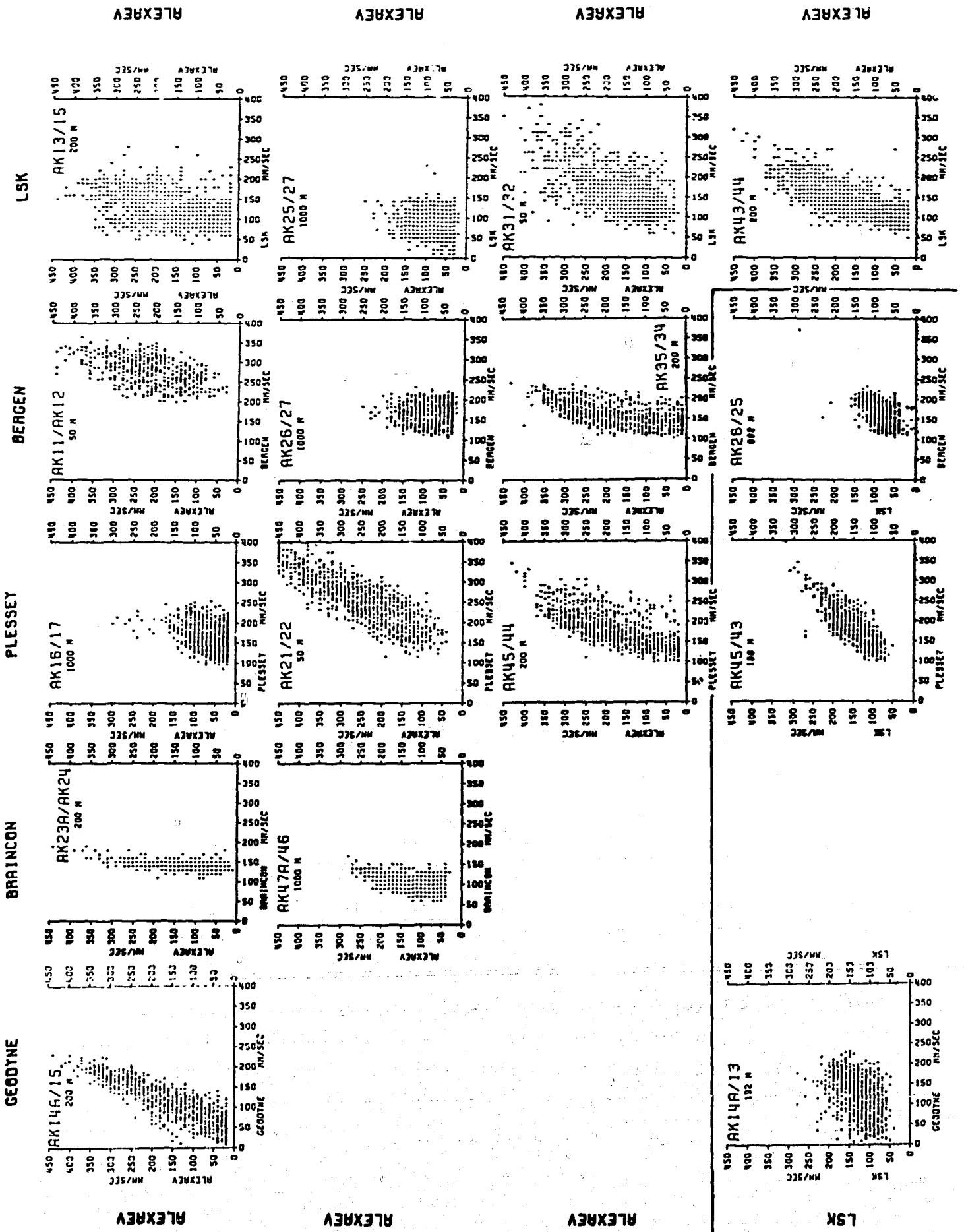

Figure 6-4 Speed versus depth plots for paired instruments.

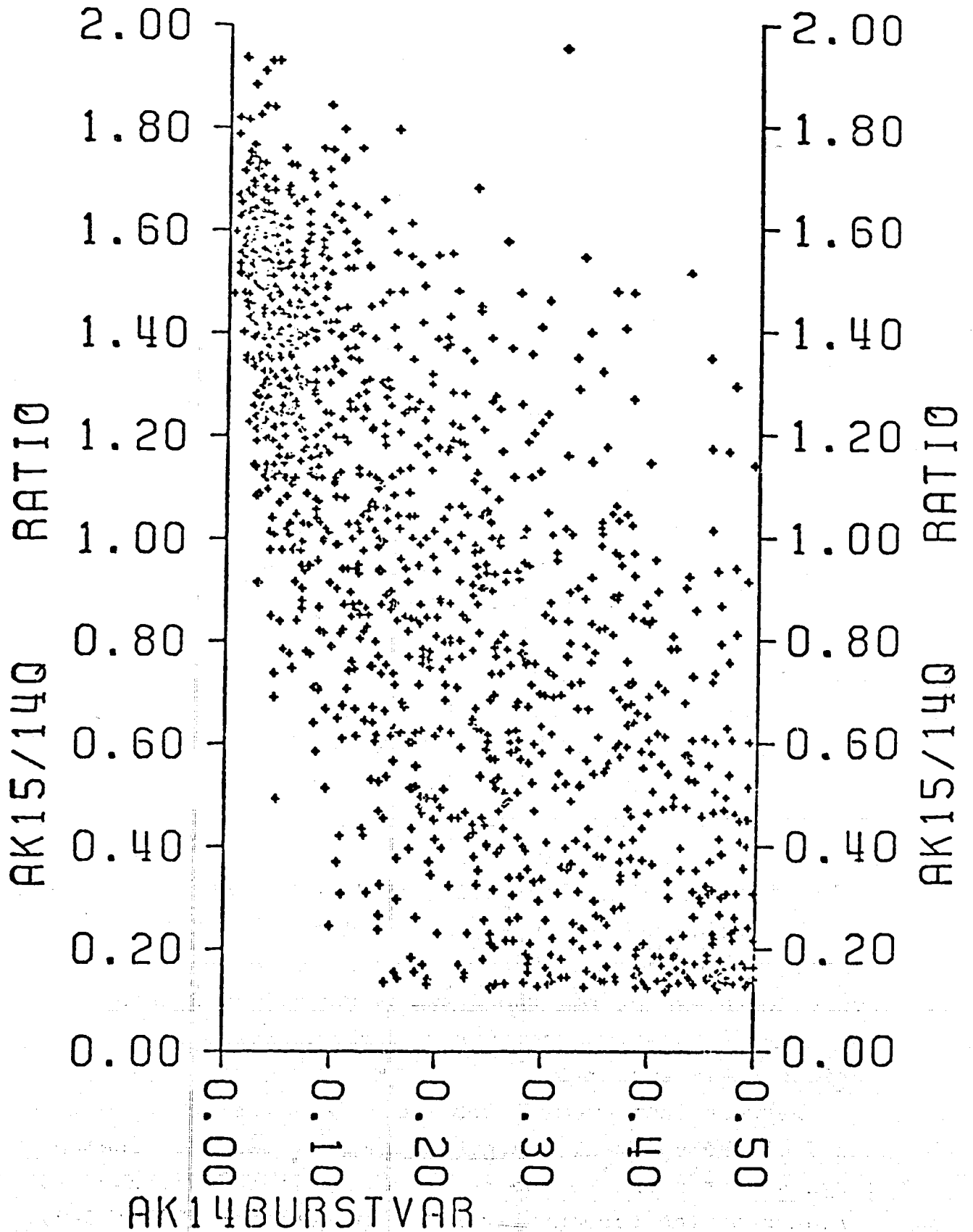

Figure 6-5 The ratio of speeds for AK 15 (ALX) to AK 14 Q (Geo) against the variance of the velocity within each corresponding burst of measurements for the AK 14 measurement.

(c) Spectral characteristics

Comparative time-dependent response can be examined by computing the spectrum of currents from each instrument over the standard time interval. A set of such spectra are included in Appendix I. General spectral properties are considered in the following section.

LOW FREQUENCY PEAKS

At low frequencies the instruments are consistent in responding to tidal and inertial-period motions. With only 12 days of measurements, the inertial-period peak, with a period of about 42.6 hours, can barely be resolved. In spite of this, a pattern in inertial-period intensity can be seen. As an example, Fig. 6-6 shows representative spectra from each of the three depths. At 50 m., no inertial peak occurs on any record. Although the 1000-m. record shows a broad spectral plateau centered on frequencies above inertial, the general pattern of 1000-m. spectra is more complex. No 1000-m. record shows an inertial peak as clearly as is found in every record from 200 m. On mooring 2, each of the three spectra from 1000-m. depth shows a peak at the adjacent higher frequency band, with a center period of 28.44 hours.

The lunar semi-diurnal tidal spectral peak (12.42 hours period) is found as a sharp clear peak on every spectrum at every depth except for those two records from Plessey instruments in which the compass was stuck for extensive periods (AK16 and AK45).

Between instrument pairs and triads the relative magnitudes of the spectral energy of the inertial and tidal peaks roughly correspond to the relative magnitude of the vector variance of the currents over all frequencies (Table 6-3).

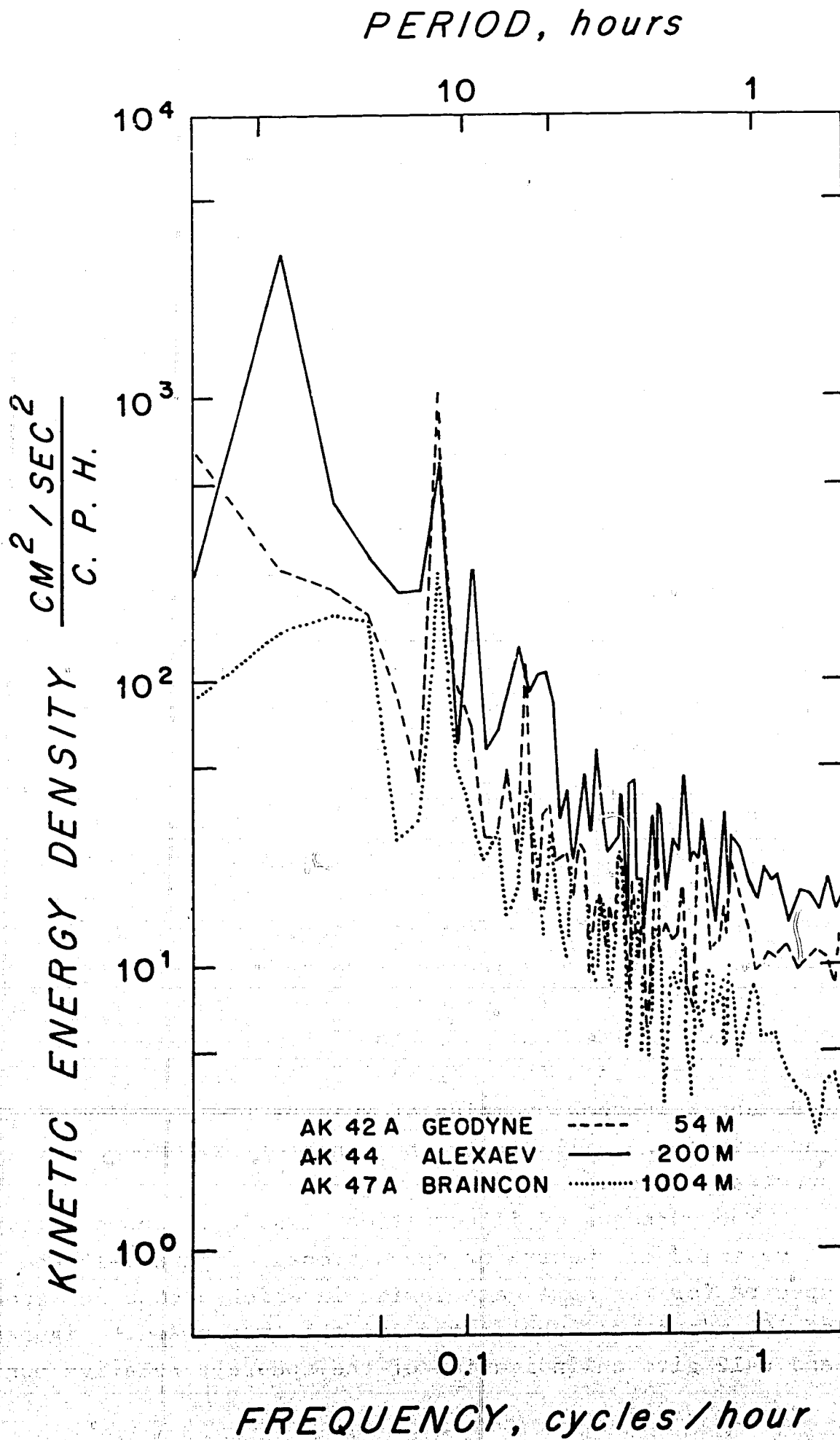

Figure 6-6 Kinetic energy density spectra from three sample depths on a log-log scale.

The spectral peaks represent averages over the length of the standard time interval. During this interval there were, however, significant time variations in the amplitudes of the tidal and inertial motions. Using the method of complex demodulation, their energy as a function of time can be estimated. The results again show that within triads and pairs the relative energy levels are roughly proportional to the variances. Figure 6-7 shows, as an example, a plot of the complex demodulate estimates at inertial period (42.67 hours) for all data from 200 m.

HIGH-FREQUENCY LEVELS

At higher frequencies, the spectra show significant differences in their relative shape. Some drop with frequency up to the Nyquist frequency (e.g. AK13, LSK). Others have an approximately level behavior above some frequency (e.g. AK22, ALX). Examples can be found for intermediate shapes. An examination of the high-frequency kinetic energy density can aid in understanding comparative instrument response.

Table 6-4 gives the kinetic energy in the band of frequencies from 1.895 to 1.973 cph. A number of patterns are evident. The LSK is always the lowest at each level. The Geodyne is the second lowest at each level, and the Braincon is generally low. The other instruments have high-frequency energy levels that can be up to 15 times greater even for paired instruments (AK13 (LSK)/AK15 (ALX)). Figures 6-8, 6-9, and 6-10 show examples of spectra from instrument pairs and triads that illustrate the range of high frequency spectral shapes.

For purposes of illustration, Fig. 6-11 shows a comparative triad of spectra of speed alone. Figure 6-12 shows spectra for the same data series in which a constant speed of 10 cm/sec was substituted for the true speed. Figures 6-11 and 6-12 give an indication of the separate relative contribu-

T = 42.67

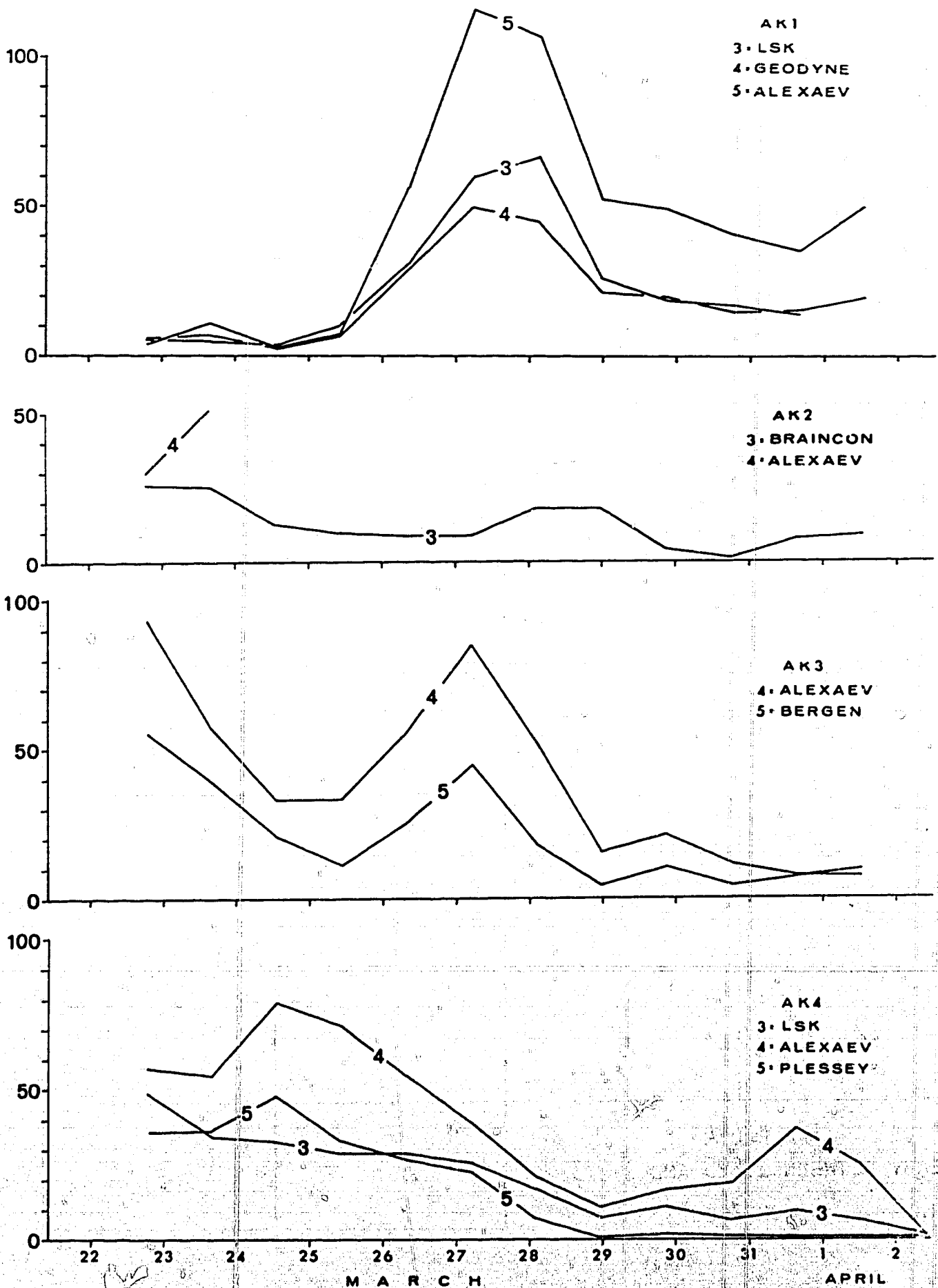

Figure 6-7 Inertial period amplitudes as a function of time at 200 m.

MOORING I		MOORING II		MOORING III		MOORING IV		DEPTH (m.)
AK11 28	REF	AK21 56	PLE	AK31 4	LSK			46
AK12	ALX	AK22 33	ALX	AK32 19	ALX	AK41	ALX	50
AK13 1	LSK			AK33	BRA	AK42A 12	GEO	54
AK14 A 5	GEO	AK23 A 6	BRA			AK43 3	LSK	196
AK15 16	ALX	AK24	ALX	AK34 11	ALX	AK44 15	ALX	200
				AK35 8	BER	AK45 13	PLE	204
		AK25 2	LSK					992
AK16 9	PLE	AK26 19	BER					996
AK17 3	ALX	AK27 5	ALX	AK36	ALX	AK46 6	ALX	1000
				AK37A 2	GEO	AK47A 3	BRA	1004

TABLE 6-4
ENERGY BETWEEN 1.895 AND 1.973
CPH. (CM²/SEC²)

tion to the high-frequency energy from speed and direction sensors. Note that, for both, the LSK spectra drop steadily to low values at high frequency.

One possible interpretation for the low LSK energy levels might be that the instrument is slow in responding to high-frequency motions. However, the period corresponding to the Nyquist frequency in the spectra presented here is half an hour. It is unlikely, with the speeds encountered in this experiment, the LSK could produce such a long time constant. Furthermore, filtering during data recording and processing is unlikely to have accounted for the low energy levels of the LSK data at high frequency. The evidence from the spectra is consistent with the conclusion that the LSK instrument was exposed to a different high-frequency motion from the other instruments.

The differences in high-frequency energy levels may be related to differences in the mounting of instruments on these moorings. It should be noted that the Geodyne, Bergen, and Braincon instruments are normally inserted in the mooring line, but in this case were offset on brackets.

PERIOD, hours

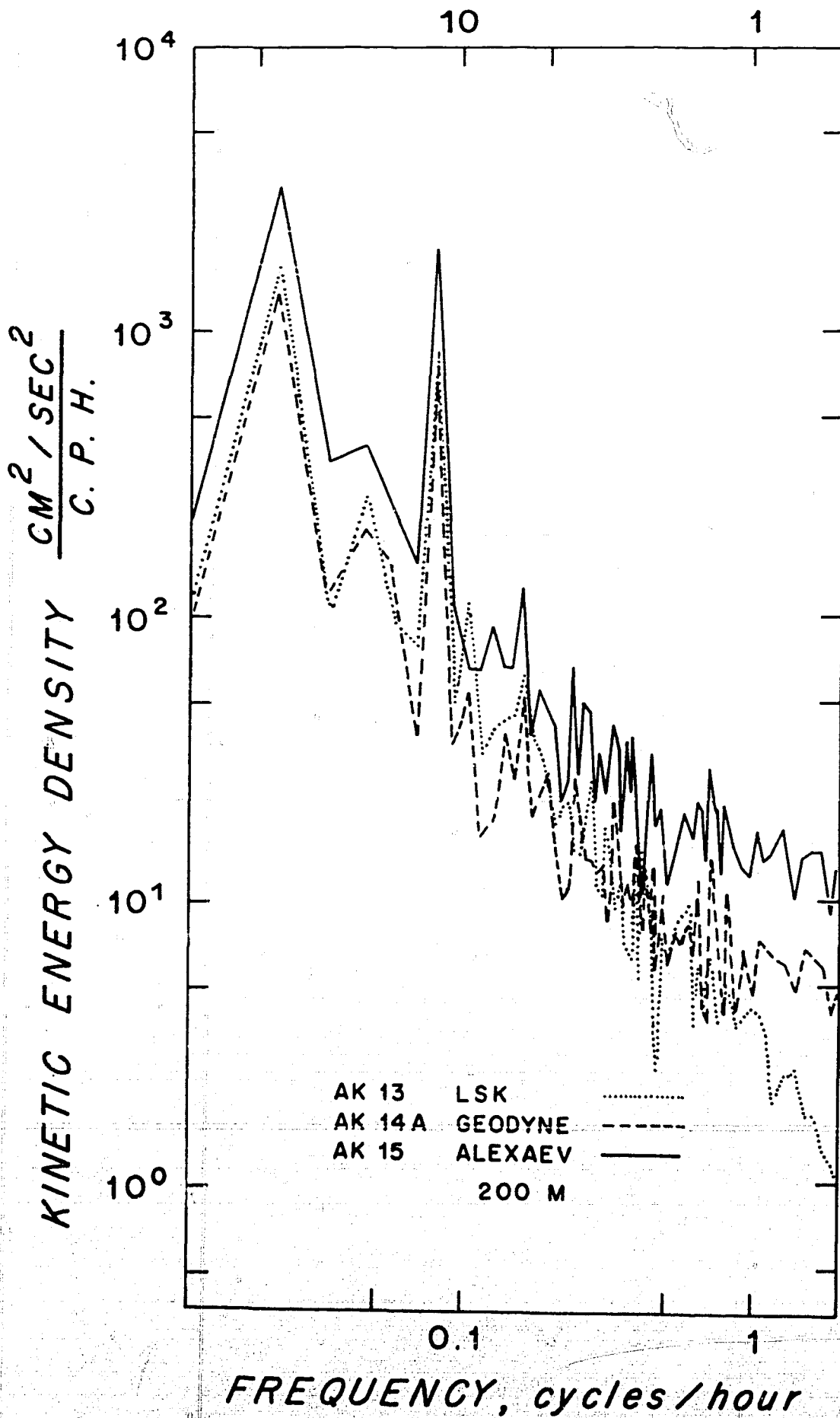

Figure 6-8 Representative spectra from 200 meters

PERIOD, hours

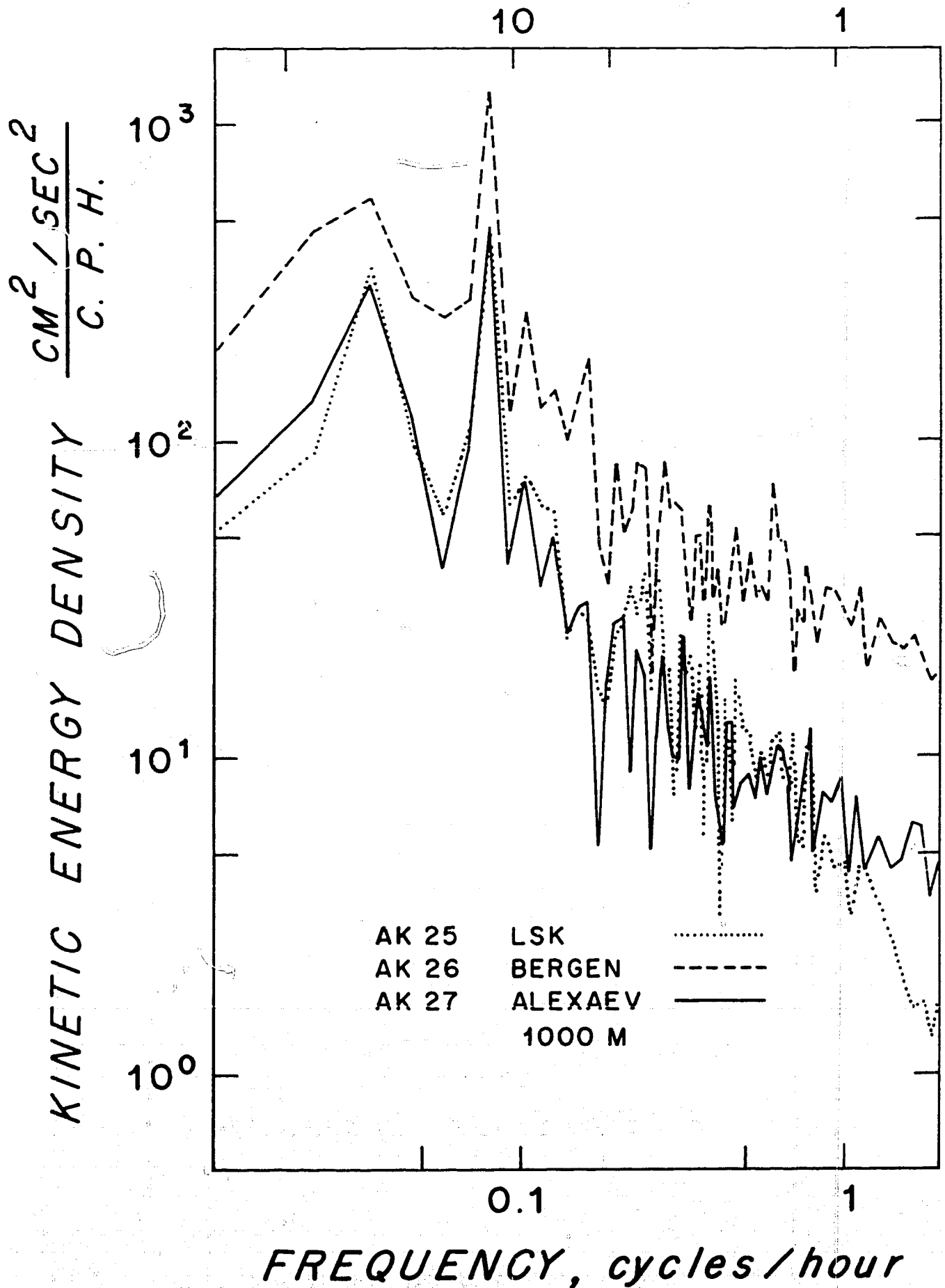

Figure 6-9 Representative spectra from 1000 m.

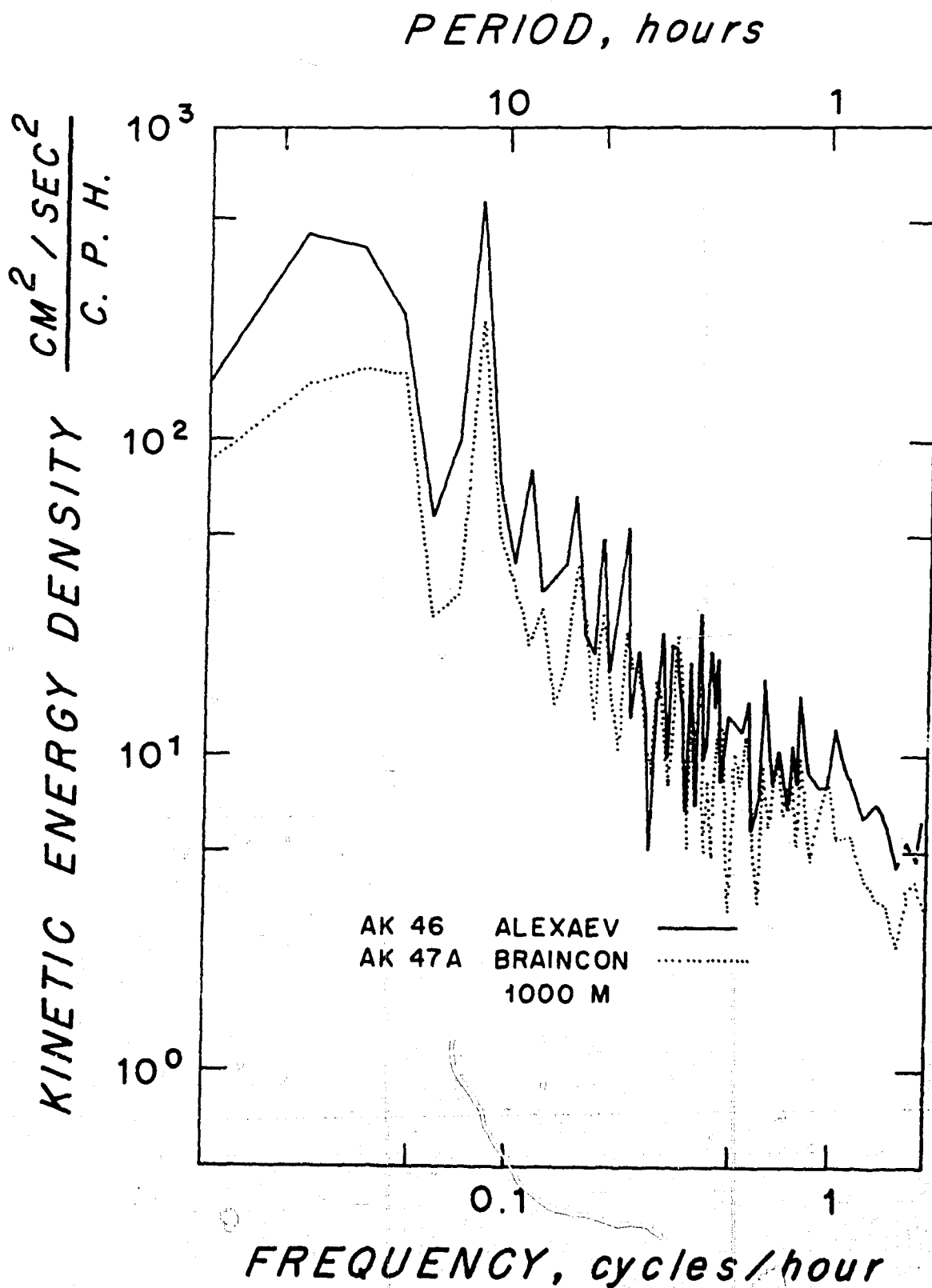

Figure 6-10 A spectral pair from 1000 m.

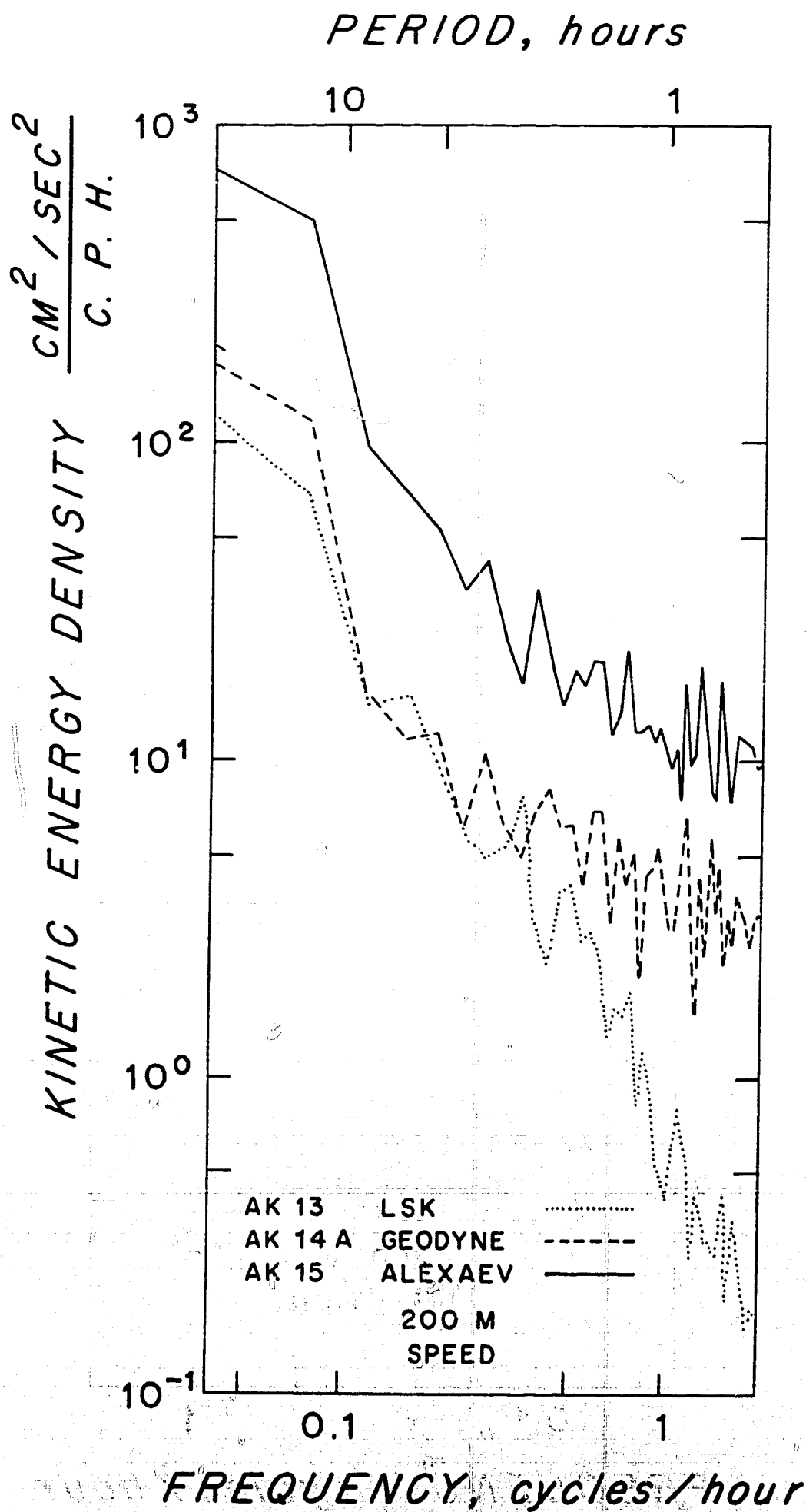

Figure 6-11 Spectrum of speed from 200 m.

(d) Cross-spectral characteristics

The correlation between pairs of instruments as it depends upon frequency can be examined by computing the coherence. The method used here is one in use at the Woods Hole Oceanographic Institution based on a program (TWOCROSS) prepared by Perkins (1970). The method has been described in detail by Gonella (1972).

The motion at each current meter is considered in terms of clockwise and anticlockwise motion. By this approach a more concise, and perhaps a more physically interpretable, form for the vector coherence can be obtained. In the first SCOR-21 report (1970) vector coherences were expressed as the average of the coherence between north components and the coherence between east components. The diagonal coherences between an east component on one instrument and a north component on the other were presumed small and ignored. Here, using the rotary form, the diagonal terms are incorporated, and the full linear coherence is included in the two curves presented for each instrument pair. The average of these curves is generally close to what would be obtained by the method used in the first SCOR-21 report. The advantages in physical understanding gained by using both clockwise and anticlockwise coherence curves makes this presentation preferable to the single average value used earlier.

For the coherences used here, there are 50 degrees of freedom corresponding to a 95% confidence level of 0.38 (Amos and Koopmans, 1963).

COHERENCE BETWEEN PAIRS

There are 13 paired data series from pairs and triads of instruments for which coherences can be estimated. These 13 pairs include 3 pairs using data from two Plessey current meters for which the compass was stuck for part of the time. In at least one case, a pair including a Plessey instrument showed moderately high coherence in spite of the compass malfunction.

Three instrument pairs have coherences that exceed 0.5 for at least one sense of rotation over the entire range of frequencies covered (0.1 cph to 2 cph). These are:

AK26/AK27 (BER-ALX)	1000 m.
AK14A/AK15 (GEO-ALX)	200 m.
AK47A/AK46 (BRA-ALX)	1000 m.

All other instrument pairs show coherences that are below 0.5 for both senses of rotation for all or part of the range of frequencies covered. For those with coherences above 0.1 for part of the frequency range, the general pattern is for the coherence to drop with increasing frequency. There is thus some frequency above which the coherence is less than 0.5 for both senses of rotation. The value of this frequency is:

<u>Pair</u>	<u>Type</u>	<u>Depth</u>	<u>Frequency at which coherence drops below 0.5</u>
AK25/AK27	(LSK-ALX)	1000 m.	0.81 cph
AK25/AK26	(LSK-BER)	1000 m.	0.74
AK34/AK35	(ALX-BER)	200 m.	0.55
AK43/AK44	(LSK-ALX)	200 m.	0.35
AK44/AK45	(ALX-PLE)	200 m.	0.30
AK31/AK32	(LSK-ALX)	50 m.	0.27
AK43/AK45	(LSK-PLE)	200 m.	0.26
AK21/AK22	(PLE-ALX)	50 m.	0.24

Two other instrument pairs, AK13/AK14A (LSK-GEO), 200 m., and AK13/AK15 (LSK-ALX), 200 m., have coherences above 0.5 at the lowest frequency estimate (0.1 cph) but at no other estimate.

No clear patterns based on instrument type emerge from the coherence calculations. The high-coherence pairs involve three different instrument types (BER, GEO, BRA) paired with Alexsev meters. The only instrument not among the highly coherent pairs is the Plessey, but this is possibly due to compass malfunction.

The two pairs involving AK13 (LSK) possibly have low coherences because of time-base irregularities. The low coherence is possibly not related to any general characteristic of the LSK instrument.

Figure 6-13 shows the coherence curves for the four instrument pairs that are most highly coherent. Figure 6-14 shows examples of other pairs that are less coherent.

COHERENCES BETWEEN MOORINGS

About a quarter of the possible horizontal pairs of instruments at the same depth were examined for coherence (14 pairs out of a possible 51). In no case did the coherence for both senses of rotation rise above 0.5. In general, the coherences are not significantly different from zero at any frequency in the range resolved (0.1 cph to 2 cph).

The progressive vector diagrams (Figure 6-1) show similar low-frequency patterns for some records at the same depth on different moorings. However, the coherence estimates over the relatively short records available do not resolve this. If there is a linear low-frequency correlation between adjacent moorings, longer records than those available here are needed to resolve it.

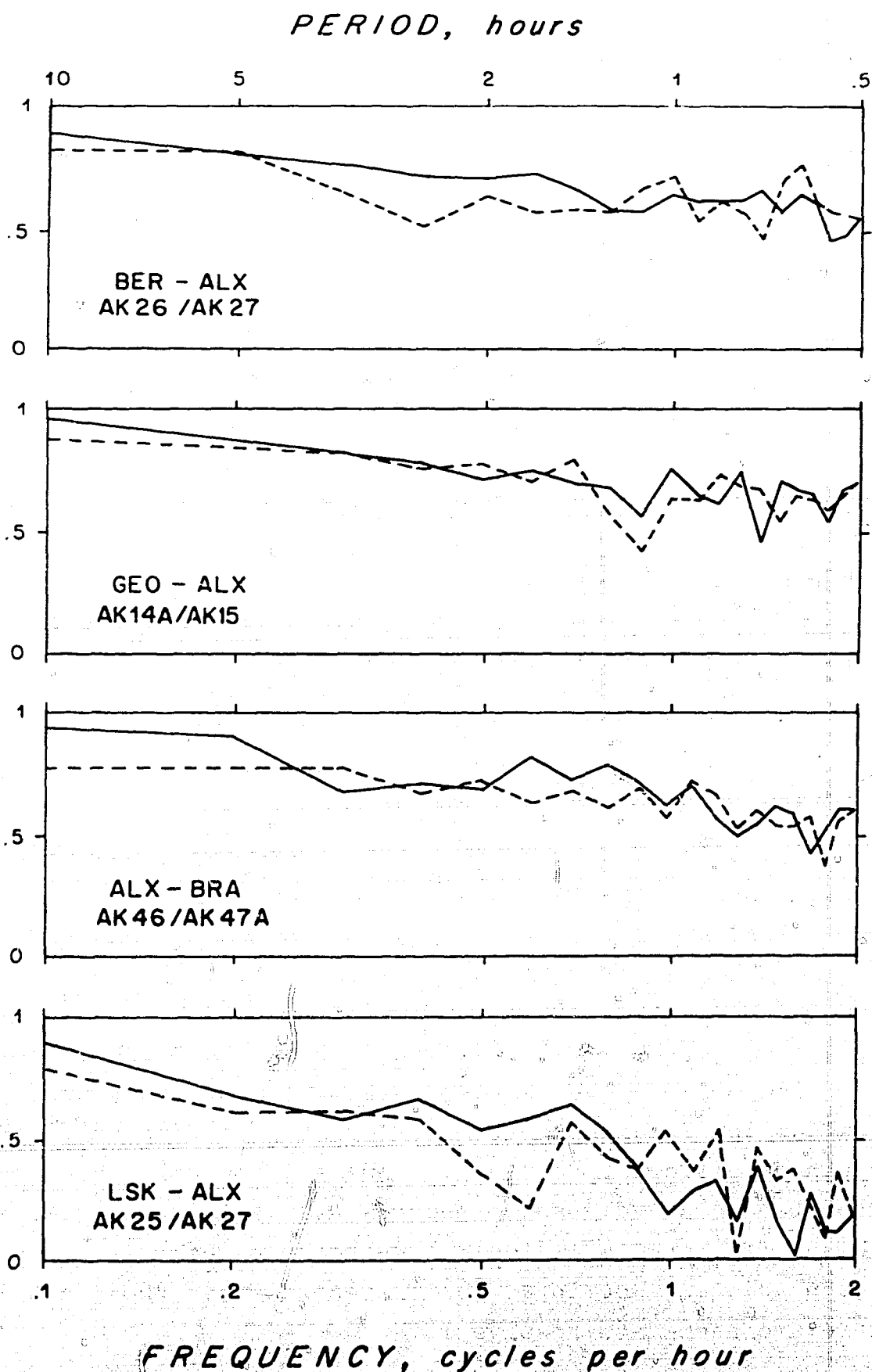

Figure 6-13 Coherences for those instrument pairs having the highest values of coherence. The solid line is the coherence for the clockwise component of motion. The dashed line is the coherence for anticlockwise component of motion. The 95% confidence level of coherence is 0.38 corresponding to 50 degrees of freedom.

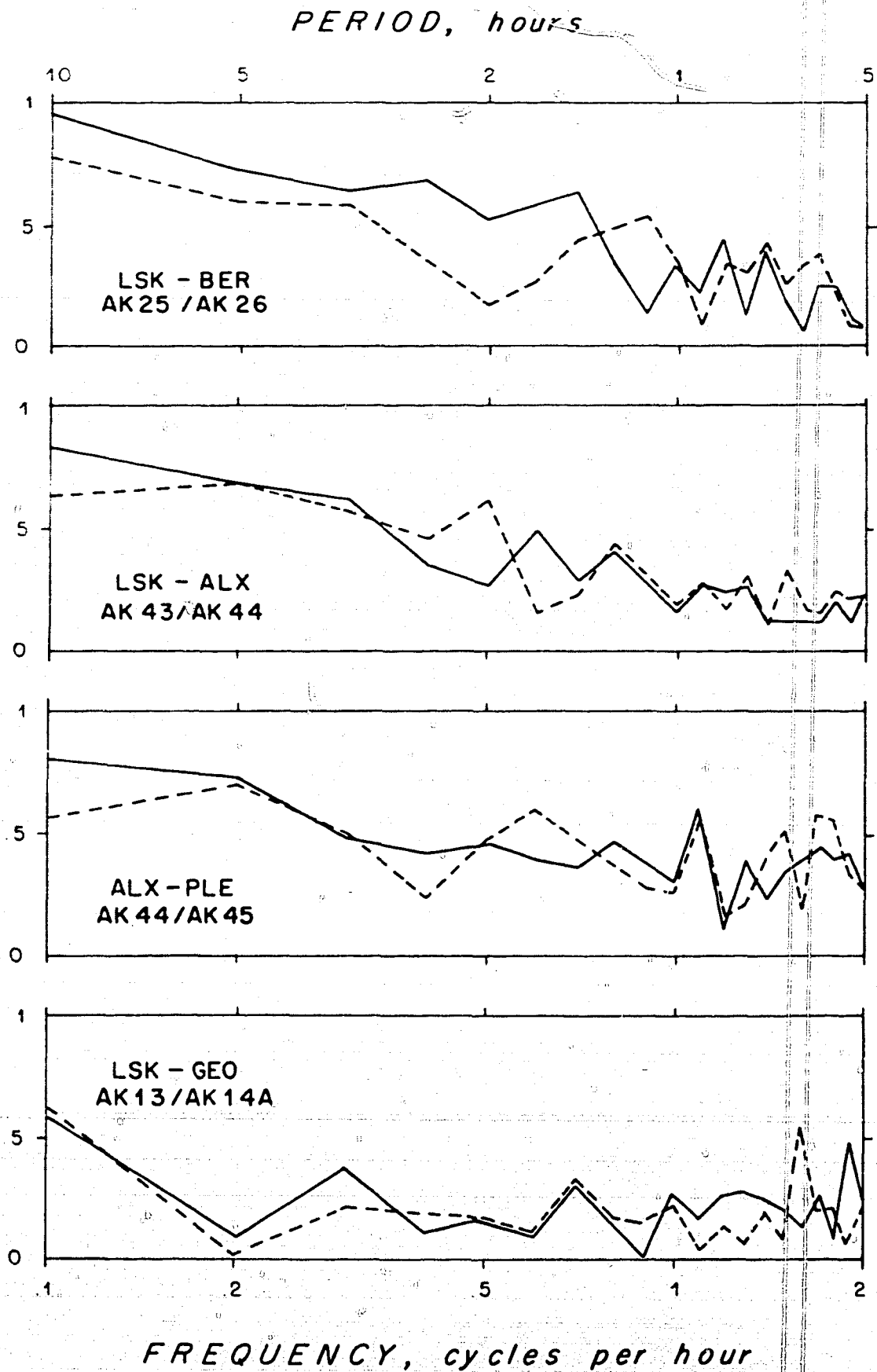

Figure 6-14 Coherences for four instrument pairs having lower values of coherence. The curves have the same interpretation as those in Figure 6-13.

7. Conclusions and Recommendations

CONCLUSIONS

1. The intercomparison experiment showed that, in the conditions encountered, paired instruments behaved with encouraging similarity in some respects (mean velocities, progressive vector diagrams). There were large differences, however, in the response of instruments to time-varying currents. Some of these differences are understandable in terms of the known characteristics of the instruments, and some are not.
2. In trying to make more precise statements about the results, some difficulties arise. For example, if we omit only the direction of AK25 it can be said that the differences between estimates of the mean velocity (Table 6-2) given by paired instruments did not exceed the tolerances for speed and direction given in the manufacturers' handbooks. However, if the speed differences are to be interpreted as being due to differences of calibration, it is implied that differences occur systematically through the whole range of speeds encountered in the experiment. It is not clear how much of the manufacturer's tolerance can be assigned to systematic errors of calibration over that speed range. Moreover, users sometimes believe that instruments differ in calibration by appreciably less than the manufacturer's tolerance, but without tow tank calibrations on the individual instruments near the time of the experiment it is not possible to be precise about what lower values to apply. The users of Bergen and LSK meters involved in the experiment

think however that the 3.8 cm/sec difference between records AK25 and AK26 in Table 6-2 is unlikely to be explainable in terms of calibration bias.

Manufacturers' tolerances for direction measurement are intended to apply to individual readings of direction, and they include the effects of both the size of the digitizing interval, and the alignment of the divisions between the intervals. With the vector mean, many samples spread over a wide range of angles are involved and the effect of the size of the digitizing interval will be much reduced. It is not known what lower value of tolerance on directions should be used. However, the observed 6° spread of directions (omitting AK25) between pairs in Table 6-2 may be contrasted with the results of the first intercomparison experiment, when systematic differences in modal direction of 20° to 34° were found. In the case of AK 25 (LSK) the control of the instrument by the manufacturer after the experiment showed an unexpected high friction of the bearing for direction setting, a defect which could be eliminated by using more effective fins.

3. The agreement in estimates of mean velocities is however largely fortuitous. The plots of speeds of paired instruments (Fig. 6-4) show that the incremental response in, for example, AK14 (Geodyne) was approximately half that of AK15 (Alexaev). A discrepancy in the same sense between other instruments and the Alexaev is less clearly indicated, due to lack of low speeds. Similar discrepancies were not observed during the 1967 intercomparison experiment. Observed differences in vector variance (Table 6-3) and in spectral distribution of kinetic energy in the 1970 data are partly due to this unexplained discrepancy in speed response.

4. The records from the Bergen, Braincon and Plessey instruments showed a striking absence of low speeds, due to the presence of appreciable energy at frequencies too high

to be resolved by the sampling regimes of those instruments. Its presence was known from the scatter within the bursts of rapid sampling in the Geodyne records. The effect of scalar averaging through the sampling period could be clearly demonstrated by contrasting plots of scalar average values from the Geodyne burst samples with those of the original vector averages. The less pronounced lack of low speeds in the LSK records could be related to the design of its speed sensor, in contrast to the omnidirectional Savonius rotor. A similar lack of low speeds was not observed during the 1967 intercomparison experiment.

Without more knowledge of the spectra of these unresolved fluctuations both in frequency and wave number, and more detailed study of the transient response of the current meters, it is not possible to determine precisely the extent to which these fluctuations contaminate the estimates of spectral energy density and mean velocities. It seems likely, though, that the observed high energy densities at high frequencies in the Bergen, Braincon and Plessey records are due to such contamination. Its effect would be expected to be more pronounced at low mean speeds, and it seems likely that in record AK26 (Bergen, 996 m) even the estimate of the vector mean is severely contaminated.

5. The relatively low estimates of energy density at high frequencies given by the LSK records seem unlikely to be wholly due to the response characteristics of the instrument or to smoothing during processing. The energy level corresponding to the speed digitizing interval in the curve follower used for reading the LSK records is at least an order of magnitude below the observed minimum values. One

might speculate that the LSK was exposed to a lower amplitude of high frequency fluctuations due to its manner of mounting directly on the mooring line instead of being offset on a bracket, but we have no positive evidence of this and the effect remains unexplained.

RECOMMENDATIONS

1. Another intercomparison should be designed to resolve the discrepancies mentioned in conclusions 3 and 5 above. Comparison should be made on both surface and subsurface moorings and instruments should preferably be mounted in the manner in which they are most commonly used. Not all the types of instrument used in this experiment need be involved; it would be sufficient if Alexaev, LSK and Geodyne were used.
2. It is recommended that users of moored current meters should study the effects of mooring design, and mounting of instruments, on the intensity of high frequency fluctuations, and the consequences of such fluctuations in contaminating the records obtained should also be studied.
3. Users of Braincon current meters might consider the possibility of extracting more information from the recorded histogram of directions, as an aid in avoiding contamination by high frequencies.

References

(a) Manufacturers' instruction manuals.

Alexaev:

Automatic recording current meters of Alexaev system,
type BPV-2 and BPV-2p.

Izdatelstvo "Morskoi Transport", Leningrad, 1963,
56 pp. (in Russian).

Bergen:

Operating manual for recording current meter, serial
no. 42-66. (undated)

I. R. Aanderaa, Nesttun, Norway.

Braincon:

Instruction manual, type 381 Histogram current meter.

(1968) Braincon Corp., Marion, Massachusetts,
17 pp. and appendices.

Rotor calibration sheets, April, 1970.

Geodyne:

Model 850 Magnetic tape recording current meter.

Instruction Manual No. B-3921, Geodyne Division,
EG&G International (1968), 48 pp.

LSK:

Description of instrument and operating instruction
for Ocean Current Meter LSK 801.1.

(1969) Institut für Meereskunde, Warnemünde, D.D.R.

Plessey:

Service manual for Recording Current Meter model M021,

Issue 1^o 6/66. The Plessey Co. Ltd., Ilford, Essex,
England.

(b) Other references

- Aanderaa, I. (1964) A recording and telemetering instrument.
NATO subcomm. on Oceanogr. Res., Tech Rept. No. 16.,
 Chr. Michelsen Inst., Bergen, Norway.
- Amos, D. E., and L. H. Koopmans (1963) Tables of the distribution of the coefficient of coherence for stationary bivariate Gaussian processes. Sandia Corp. Monograph SCR-483, 327 pp.
- Dahl, O. (1969) The capability of the Aanderaa recording and telemetering instrument. in: Progress in Oceanography 5, M. Sears, ed., Pergamon Press, pp. 103-106.
- Fofonoff, N. P., and Y. Ercan (1967) Response characteristics of a Savonius rotor current meter. W.H.O.I. Ref. 67-33. 46 pp. (unpublished manuscript).
- Gonella, J. (1972) A rotary-components method for analysing the coupling between wind and surface current. Deep-Sea Research 19, 833-846.
- Maltais, J. A. (1969) A nine channel digital magnetic tape format for storing oceanographic data. W.H.O.I. Ref. 69-55, 11 pp. (unpublished manuscript).
- Perkins, H. T. (1970) Inertial oscillations in the Mediterranean. Ph.D. thesis, M.I.T.-W.H.O.I. Joint Program.
- SCOR Working Group 21 (1969) An intercomparison of some current meters. UNESCO Tech. Paps. in Marine Sci., 11. UNESCO, Paris, 70 pp.

Appendix

DATA PLOTS

STATS

E = EAST
N = NORTH
UNITS = MM/SEC
UNITS = MM/SEC

DATE	HR	MIN	SEC	MEAN (E)	MEAN (N)	VECT3R MEAN	VARIANCE (E)	VARIANCE (N)	VECTOR VARIANCE	COVARIANCE (E & N)
70- III-22	12	0	3	-175.	149.	229.	17781.78	11842.20	14811.99	7066.62
70- III-23	12	0	3	-185.	96.	200.	27754.37	27052.31	27403.34	8051.16
70- III-24	12	0	3	-170.	124.	210.	17659.00	14161.79	15910.39	9563.63
70- III-25	12	0	3	-124.	115.	169.	11764.74	14839.95	13297.31	5059.48
70- III-26	12	0	3	-112.	73.	134.	23765.23	14855.97	20310.59	7665.79
70- III-27	12	0	3	-123.	120.	174.	23823.27	17713.25	20768.26	10743.84
70- III-28	12	0	3	-92.	162.	187.	21594.72	11448.09	16621.41	7046.61
70- III-29	12	0	3	-95.	158.	185.	8281.18	10799.04	9540.11	5176.67
70- III-30	12	0	3	-125.	81.	121.	9150.80	24046.22	16598.51	3781.97
70- III-31	12	0	3	-120.	89.	150.	12731.36	10451.54	11591.45	-2420.15
70- IV - 1	12	0	3	17.	77.	79.	28730.91	34312.47	31521.48	3991.29

SPEED
UNITS = MM/SEC

MEAN (S)	VARIANCE (S)
286.	463.02
312.	470.22
275.	441.45
234.	305.24
241.	426.44
269.	445.93
250.	521.28
229.	748.46
218.	405.49
213.	344.40
255.	495.16

STATS

*** EAST ***
*** MM/SEC ***
MEAN = -12.0001 ST. ERR = 0.35
VARIANCE = 1.93507
STD. DEV. = 1.39249
KURTOSIS = 3.003
SKEW. ESS = 1.001

*** NORTH ***
*** MM/SEC ***
MEAN = 94.936 ST. ERR = 0.58
VARIANCE = 21.44913
STD. DEV. = 4.63135
KURTOSIS = 2.416
SKEW. ESS = -0.664

*** SPEED ***
*** MM/SEC ***
MEAN = 201.75 ST. ERR = 1.14
VARIANCE = 1327.29
STD. DEV. = 36.57
KURTOSIS = 2.406
SKEW. ESS = 0.930

*** EAST ***
*** NORTH ***
COVARIANCE = 4.21047 ST. ERR = 21.467
STD. DEV. OF COVARIANCE = 227.145
CORRELATION COEFFICIENT = 0.995

***** EAST & NORTH *****
***** EAST & NORTH *****
MEAN = 1.7075
VARIANCE = 25.18007
STD. DEV. = 5.01800

SAMPLE SIZE = 1000 POINTS

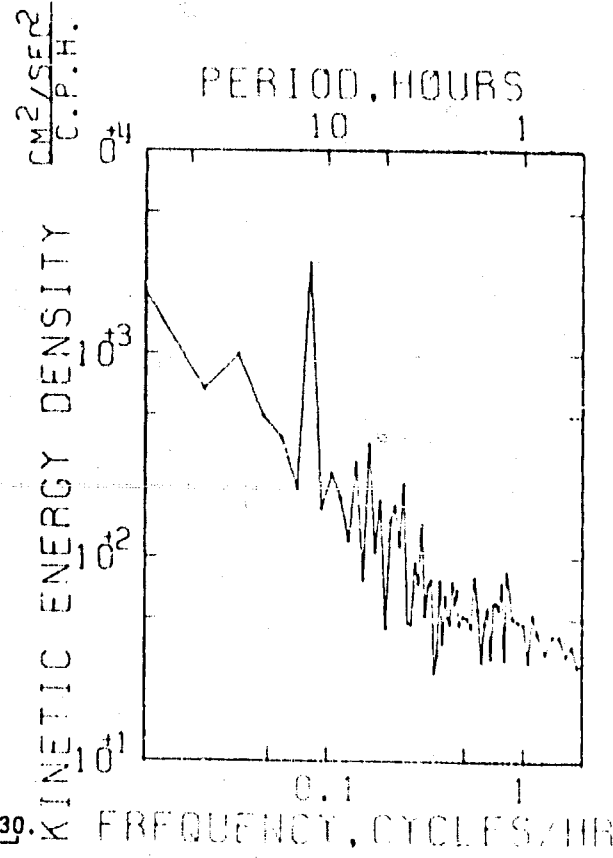
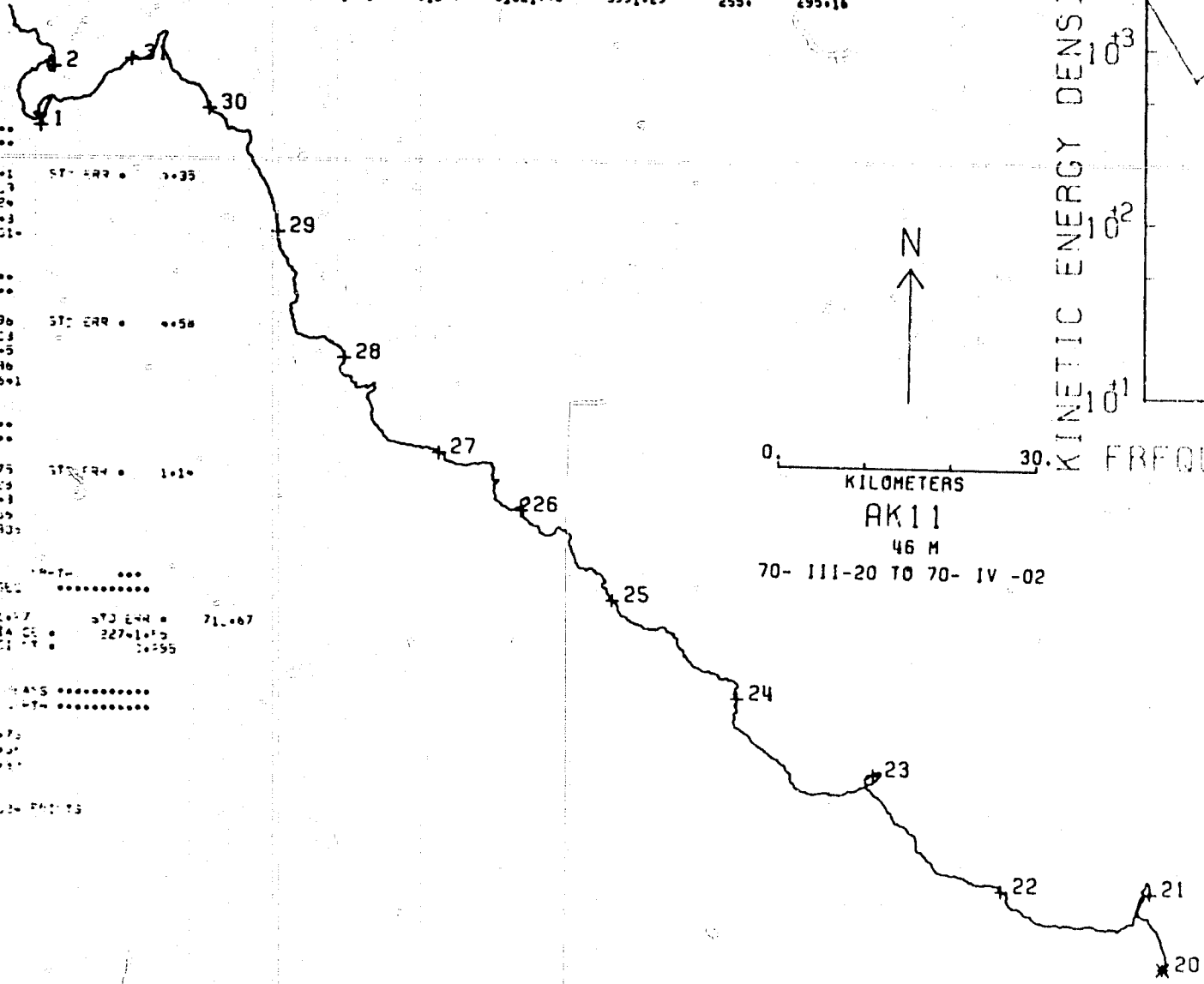

0 30 KILOMETERS
AK11
46 M
70- III-20 TO 70- IV -02

AK11 BERGEN

TIME	DATA	PLATTING BEARING	SPEED
00:00	000000	000000	000000
00:01	000000	000000	000000
00:02	000000	000000	000000
00:03	000000	000000	000000
00:04	000000	000000	000000
00:05	000000	000000	000000
00:06	000000	000000	000000
00:07	000000	000000	000000
00:08	000000	000000	000000
00:09	000000	000000	000000
00:10	000000	000000	000000
00:11	000000	000000	000000
00:12	000000	000000	000000
00:13	000000	000000	000000
00:14	000000	000000	000000
00:15	000000	000000	000000
00:16	000000	000000	000000
00:17	000000	000000	000000
00:18	000000	000000	000000
00:19	000000	000000	000000
00:20	000000	000000	000000
00:21	000000	000000	000000
00:22	000000	000000	000000
00:23	000000	000000	000000
00:24	000000	000000	000000
00:25	000000	000000	000000
00:26	000000	000000	000000
00:27	000000	000000	000000
00:28	000000	000000	000000
00:29	000000	000000	000000
00:30	000000	000000	000000
00:31	000000	000000	000000
00:32	000000	000000	000000
00:33	000000	000000	000000
00:34	000000	000000	000000
00:35	000000	000000	000000
00:36	000000	000000	000000
00:37	000000	000000	000000
00:38	000000	000000	000000
00:39	000000	000000	000000
00:40	000000	000000	000000
00:41	000000	000000	000000
00:42	000000	000000	000000
00:43	000000	000000	000000
00:44	000000	000000	000000
00:45	000000	000000	000000
00:46	000000	000000	000000
00:47	000000	000000	000000
00:48	000000	000000	000000
00:49	000000	000000	000000
00:50	000000	000000	000000
00:51	000000	000000	000000
00:52	000000	000000	000000
00:53	000000	000000	000000
00:54	000000	000000	000000
00:55	000000	000000	000000
00:56	000000	000000	000000
00:57	000000	000000	000000
00:58	000000	000000	000000
00:59	000000	000000	000000
01:00	000000	000000	000000

DATA #11
 SAMPLE RATE = 17000.00 HERTZ
 PLATTING BEARING
 FROM 70 111-02 11-00-23
 TO 70 111-02 11-30-23
 AVERAGE NUMBER OF SAMPLES PER SECOND = 12
 TOTAL NUMBER OF DATA SAMPLES = 102
 NUMBER OF VALID DATA SAMPLES = 0

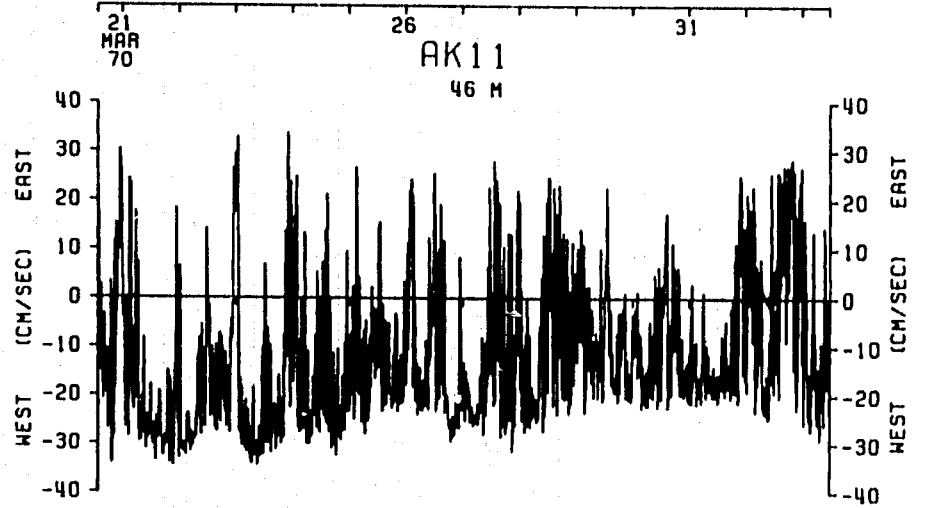
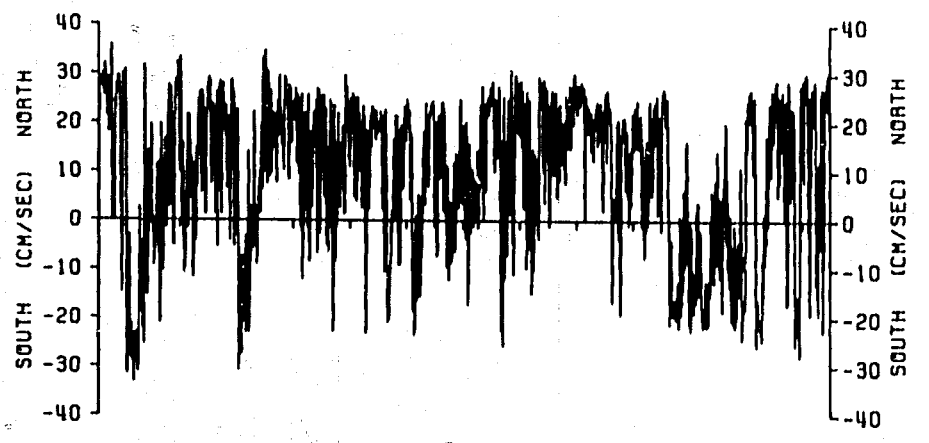

AK11
 BERGEN



0. 30.
KILOMETERS
AK12
50 M
70- 111-20 TO 70- 111-26

AK 12
ALEXAEV

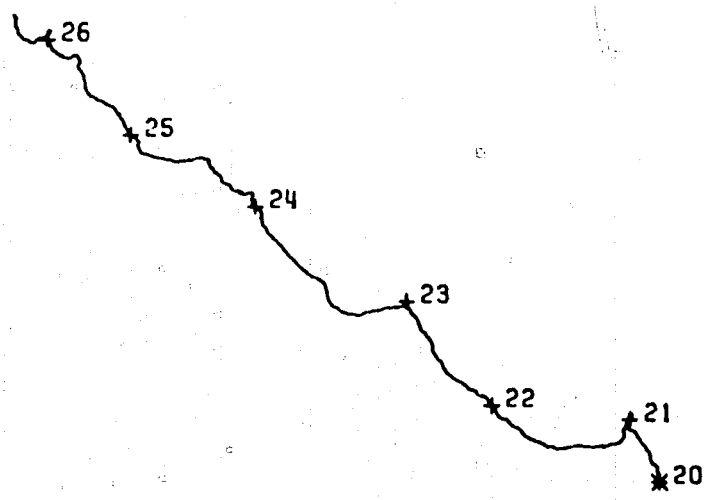

TIME HISTOGRAM

TIME	DIRECTION DEGREES	DATA/ AK12
201645	5	5 558 8558
201945	5	58 585 55 5 5
202245	5	5 5 5 5 5 5 5 5
210145	5	5 5 5 5 5 5 5 5
210445	5	5 5 5 5 5 5 5 5
210745	5	5 5 5 5 5 5 5 5
211045	5	5 5 5 5 5 5 5 5
211345	5	5 5 5 5 5 5 5 5
211645	5	5 5 5 5 5 5 5 5
211945	5	5 5 5 5 5 5 5 5
212245	5	5 5 5 5 5 5 5 5
220145	5	5 5 5 5 5 5 5 5
220445	5	5 5 5 5 5 5 5 5
220745	5	5 5 5 5 5 5 5 5
221045	5	5 5 5 5 5 5 5 5
221345	5	5 5 5 5 5 5 5 5
221645	5	5 5 5 5 5 5 5 5
221945	5	5 5 5 5 5 5 5 5
222245	5	5 5 5 5 5 5 5 5
230145	5	5 5 5 5 5 5 5 5
230445	5	5 5 5 5 5 5 5 5
230745	5	5 5 5 5 5 5 5 5
231045	5	5 5 5 5 5 5 5 5
231345	5	5 5 5 5 5 5 5 5
231645	5	5 5 5 5 5 5 5 5
231945	5	5 5 5 5 5 5 5 5
232245	5	5 5 5 5 5 5 5 5
240145	5	5 5 5 5 5 5 5 5
240445	5	5 5 5 5 5 5 5 5
240745	5	5 5 5 5 5 5 5 5
241045	5	5 5 5 5 5 5 5 5
241345	5	5 5 5 5 5 5 5 5
241645	5	5 5 5 5 5 5 5 5
241945	5	5 5 5 5 5 5 5 5
242245	5	5 5 5 5 5 5 5 5
250145	5	5 5 5 5 5 5 5 5
250445	5	5 5 5 5 5 5 5 5
250745	5	5 5 5 5 5 5 5 5
251045	5	5 5 5 5 5 5 5 5
251345	5	5 5 5 5 5 5 5 5
251645	5	5 5 5 5 5 5 5 5
251945	5	5 5 5 5 5 5 5 5
252245	5	5 5 5 5 5 5 5 5
260145	5	5 5 5 5 5 5 5 5
260445	5	5 5 5 5 5 5 5 5
260745	5	5 5 5 5 5 5 5 5
261045	5	5 5 5 5 5 5 5 5
261345	5	5 5 5 5 5 5 5 5
261645	5	5 5 5 5 5 5 5 5
261945	5	5 5 5 5 5 5 5 5
262245	5	5 5 5 5 5 5 5 5

DATA/ AK12
 SAMPLE SIZE = 1:430:000 SECONDS

DATA/ AK12

TIME	SPEED MM/SEC	PLOTTING BEGINS/ 70- 111-23 13-18-00
201645	4 0 5 55 85 5 5	
201945	4 6 33 33 3	
202245	5 5 5 85 54 35 5	33
210145	5 55 8 85 3 5	
210445	5 5 55 555 5 555	
210745	3 38 3 3 33	33 3
211045	5 555 58 8 8 5	
211345	5 5 5 5 5 5 5 5	
211645	5 8 8 5 58 55 5 5	3 3
211945	5 8 55 55 55 5 5	3 3
212245	8 633 36 3 1	3
220145	55 625 2	
220445	3 8 16 6 63	
220745	3 33 63 33 3	
221045	3 23 8 8 33 6 6	
221345	8 58 55 5 5 5 5	
221645	5 5 55 8 8 5 55	
221945	55 5 4 555 8 8	
222245	6 36 86 3 3	
230145	8 5 55 88 5 4	
230445	8 5 5 5 5 5 5 5 5	
230745	55 54 8 58 55	
231045	55 5 5 5 5 5 5 584	
231345	6 333 3 4 85 8 8	3
231645	22 2 2 7 8	3
231945	5 5 5 5 5 5 5 555	
232245	5 855 5 58 8 5	
240145	86 3 38 3 3 3	
240445	5 5 58 8 5 5 58	3 633 3
240745	5 5 8 33 6 33 3 1 5 58	
241045	5 5 5 5 5 5 5 5 5 8	
241345	3 3 3 3 3 3 3 3 3 5 55 85 5 5	
241645	3 3 3 3 3 3 3 3 3 3 3	
241945	3 3 3 3 3 3 3 3 3 3 3	
242245	3 3 3 3 3 3 3 3 3 3 3	
250145	3 3 3 3 3 3 3 3 3 3 3	
250445	3 3 3 3 3 3 3 3 3 3 3	
250745	3 3 3 3 3 3 3 3 3 3 3	
251045	3 3 3 3 3 3 3 3 3 3 3	
251345	3 3 3 3 3 3 3 3 3 3 3	
251645	3 3 3 3 3 3 3 3 3 3 3	
251945	3 3 3 3 3 3 3 3 3 3 3	
252245	3 3 3 3 3 3 3 3 3 3 3	
260145	3 3 3 3 3 3 3 3 3 3 3	
260445	3 3 3 3 3 3 3 3 3 3 3	
260745	3 3 3 3 3 3 3 3 3 3 3	
261045	3 3 3 3 3 3 3 3 3 3 3	
261345	3 3 3 3 3 3 3 3 3 3 3	
261645	3 3 3 3 3 3 3 3 3 3 3	
261945	3 3 3 3 3 3 3 3 3 3 3	
262245	3 3 3 3 3 3 3 3 3 3 3	

AK12
 ALEXAEV

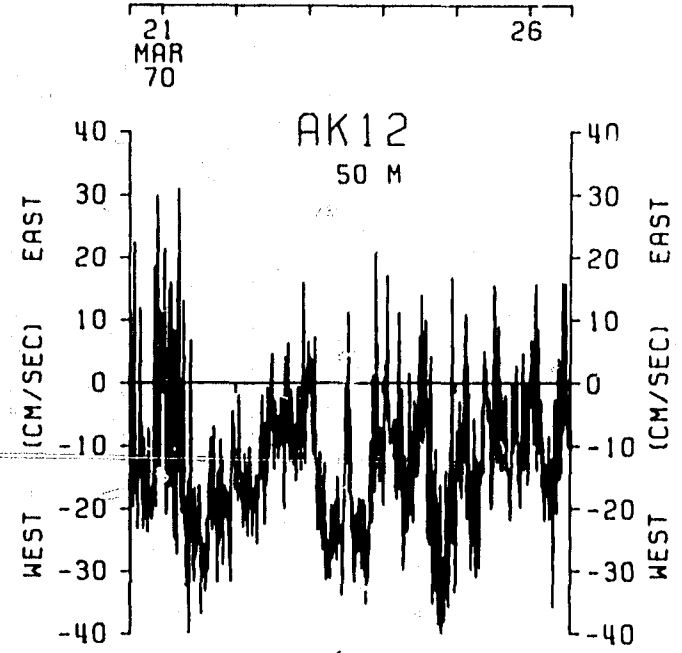
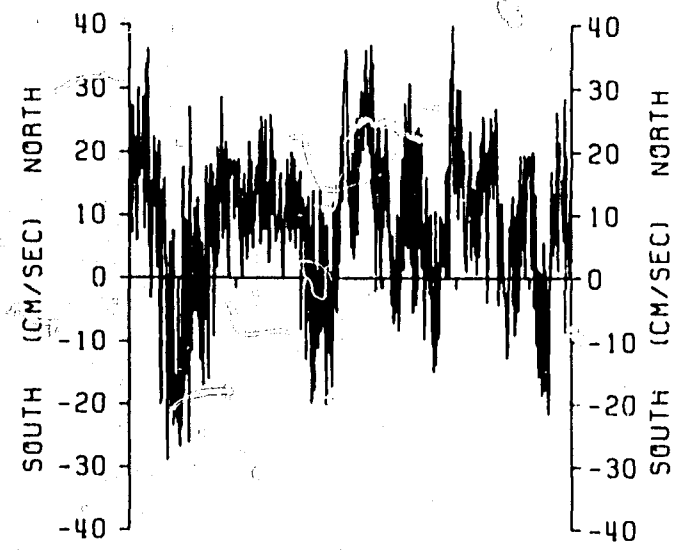

STATS

DATE	MID TIME		MEAN		VECTOR MEAN	VARIANCE (E)	VARIANCE (N)	VECTOR VARIANCE	COVARIANCE (E & N)	SPEED		
	HR	MIN	SEC	(E)						(N)	MEAN (E)	VARIANCE (N)
70- 111-22	12	0	0	+3.	59.	355.27	3791.68	3672.87	-27.36	102.	291.13	
70- 111-23	12	0	0	+3.	63.	284.80	2058.79	2451.79	499.87	98.	436.24	
70- 111-24	12	0	0	-21.	62.	2499.22	2739.05	2400.13	948.59	95.	462.69	
70- 111-25	12	0	0	-18.	79.	506.32	5012.20	5338.26	332.35	12.	1330.16	
70- 111-26	12	0	0	-103.	91.	14.51	5792.85	3619.68	-100.13	135.	1370.79	
70- 111-27	12	0	0	10.	69.	7550.05	10137.95	8844.00	-679.06	145.	1550.16	
70- 111-28	12	0	0	-111.	74.	133.	4282.11	7658.09	5970.10	1876.40	169.	1018.06
70- 111-29	12	0	0	+43.	48.	64.	2826.23	4642.87	3730.55	366.93	104.	790.58
70- 111-30	12	0	0	-65.	102.	121.	5918.95	2730.67	4326.81	1060.05	148.	1515.01
70- 111-31	12	0	0	-69.	59.	91.	1580.13	2206.82	1893.48	133.21	106.	937.11
70- IV - 1	12	0	0	-33.	71.	78.	6497.67	4103.62	5300.54	-37.93	130.	1129.67

STAT: ...

MEAN: ... 2.32

VARIANCE: ...

STD. DEV.: ...

KURT. SIS: ...

SKEW. SIS: ...

MEAN: ... 2.22

VARIANCE: ...

STD. DEV.: ...

KURT. SIS: ...

SKEW. SIS: ...

MEAN: ... 1.22

VARIANCE: ...

STD. DEV.: ...

KURT. SIS: ...

SKEW. SIS: ...

COV. CORR. ...

STD. CORR. ...

COV. CORR. ...

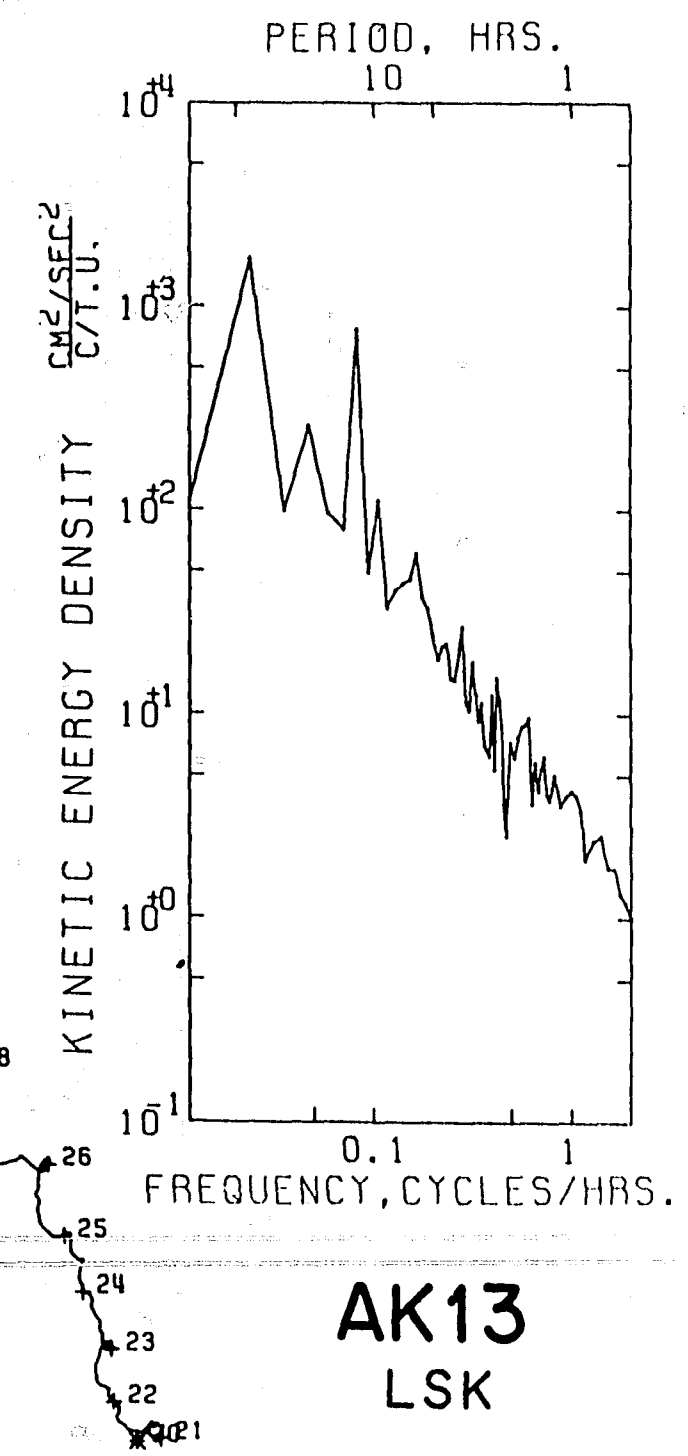
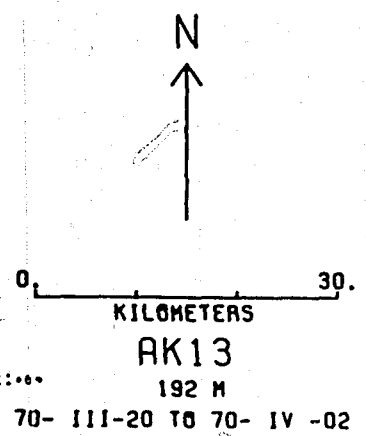

TIME	DEPTH	TEMP	SPEED
00	00	00	00
01	01	01	01
02	02	02	02
03	03	03	03
04	04	04	04
05	05	05	05
06	06	06	06
07	07	07	07
08	08	08	08
09	09	09	09
10	10	10	10
11	11	11	11
12	12	12	12
13	13	13	13
14	14	14	14
15	15	15	15
16	16	16	16
17	17	17	17
18	18	18	18
19	19	19	19
20	20	20	20
21	21	21	21
22	22	22	22
23	23	23	23
24	24	24	24
25	25	25	25
26	26	26	26
27	27	27	27
28	28	28	28
29	29	29	29
30	30	30	30
31	31	31	31
32	32	32	32
33	33	33	33
34	34	34	34
35	35	35	35
36	36	36	36
37	37	37	37
38	38	38	38
39	39	39	39
40	40	40	40
41	41	41	41
42	42	42	42
43	43	43	43
44	44	44	44
45	45	45	45
46	46	46	46
47	47	47	47
48	48	48	48
49	49	49	49
50	50	50	50
51	51	51	51
52	52	52	52
53	53	53	53
54	54	54	54
55	55	55	55
56	56	56	56
57	57	57	57
58	58	58	58
59	59	59	59
60	60	60	60

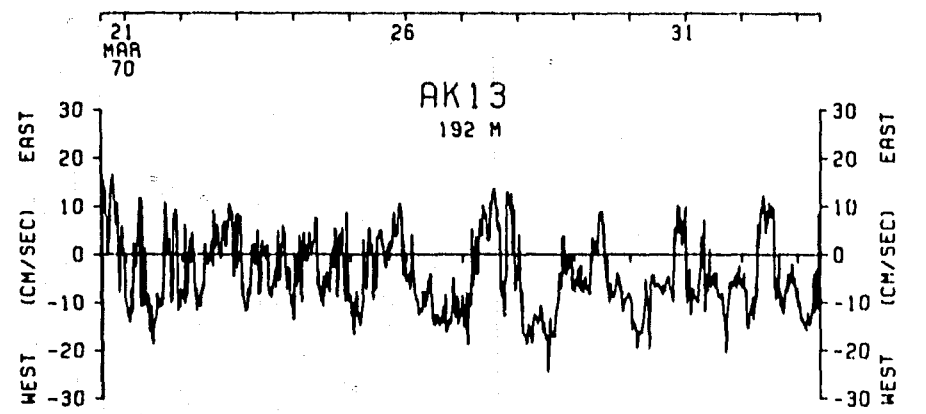
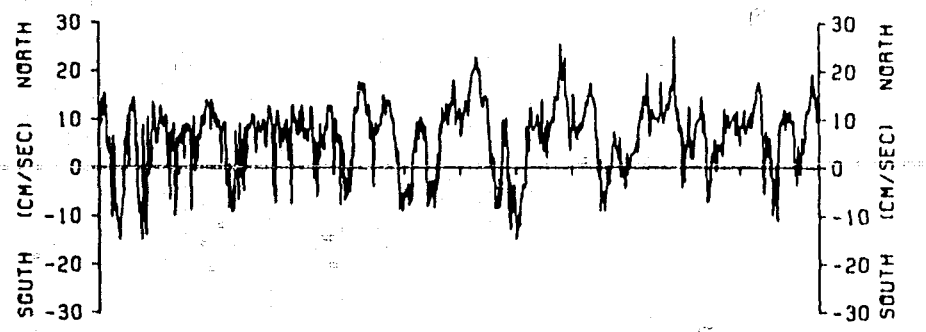

AK13
LSK

DATA: AK13
 SAMPLE RATE = 1000000 Hz
 SAMPLES PER SEC = 1000000
 TOTAL NUMBER OF DATA SAMPLES = 100
 NUMBER OF PACES DATA SAMPLES = 6

STAT500

E • EAST UNITS • MM/SEC
 S • SOUTH UNITS • MM/SEC

CAT.	TIME	MEAN (E)	MEAN (S)	VECTOR MEAN	VARIANCE (E)	VARIANCE (S)	VECTOR VARIANCE	COVARIANCE (E & S)
7C- III-22	12:11:49	-18.	53.	53.	2602.78	5670.58	+136.68	622.30
7C- III-23	12:11:49	-55.	63.	4.	2130.96	2877.56	2507.26	525.26
7C- III-24	12:11:49	-75.	52.	50.	2857.66	5670.65	+160.15	1732.42
7C- III-25	12:11:49	-13.	60.	40.	4572.18	6256.25	5010.21	303.72
7C- III-26	12:11:49	-52.	71.	110.	1870.66	5558.56	3716.71	1046.28
7C- III-27	12:11:49	16.	41.	40.	5211.55	9798.85	7505.20	2071.49
7C- III-28	12:11:49	-93.	89.	129.	5180.60	3863.83	4522.22	1882.12
7C- III-29	12:11:49	-30.	20.	6.	2638.43	3903.68	3291.56	67.86
7C- III-30	12:11:49	-65.	85.	120.	6913.99	3352.40	4133.19	1263.23
7C- III-31	12:11:49	-68.	68.	82.	2867.29	3246.50	3054.92	+436.89
7C- IV -01	12:11:49	-20.	75.	70.	7970.03	5150.85	6562.44	620.32

SPEED UNITS • MM/SEC

MEAN (E)	VARIANCE (E)
92.	1657.66
103.	1189.66
91.	1386.08
100.	1830.23
110.	2126.68
110.	1602.22
100.	2987.66
137.	2513.55
110.	2200.10
113.	2281.72
97.	2233.20

STAT500

*** EAST ***
 *** MM/SEC ***
 MEAN • -43.30 STD ERR • 2.18
 VARIANCE • 4881.71
 STD. DEV. • 69.87
 KURTOSIS • 2.50
 SKEWNESS • .087

*** NORTH ***
 *** MM/SEC ***
 MEAN • 59.36 STD ERR • 2.23
 VARIANCE • 5362.10
 STD. DEV. • 73.23
 KURTOSIS • 2.92
 SKEWNESS • -.320

*** SPEED ***
 *** MM/SEC ***
 MEAN • 115.53 STD ERR • 1.50
 VARIANCE • 2295.68
 STD. DEV. • 47.91
 KURTOSIS • 2.22
 SKEWNESS • -.029

*** EAST & NORTH ***
 ***** MM/SEC *****
 COVARIANCE • 506.30 STD ERR • 201.26
 STD. DEV. OF COVARIANCE • 6440.30
 CORRELATION COEFFICIENT • .107

***** VECTOR MEANS *****
 ***** EAST & NORTH *****
 MEAN • 73.68
 VARIANCE • 5121.92
 STD. DEV. • 71.57

SAMPLE SIZE • 1020 POINTS

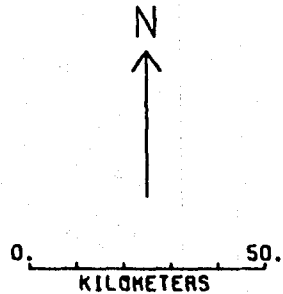

AK14A
 195 M
 70- III-20 TO 70- IV -02

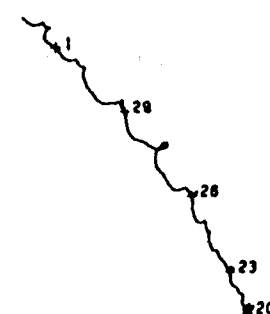
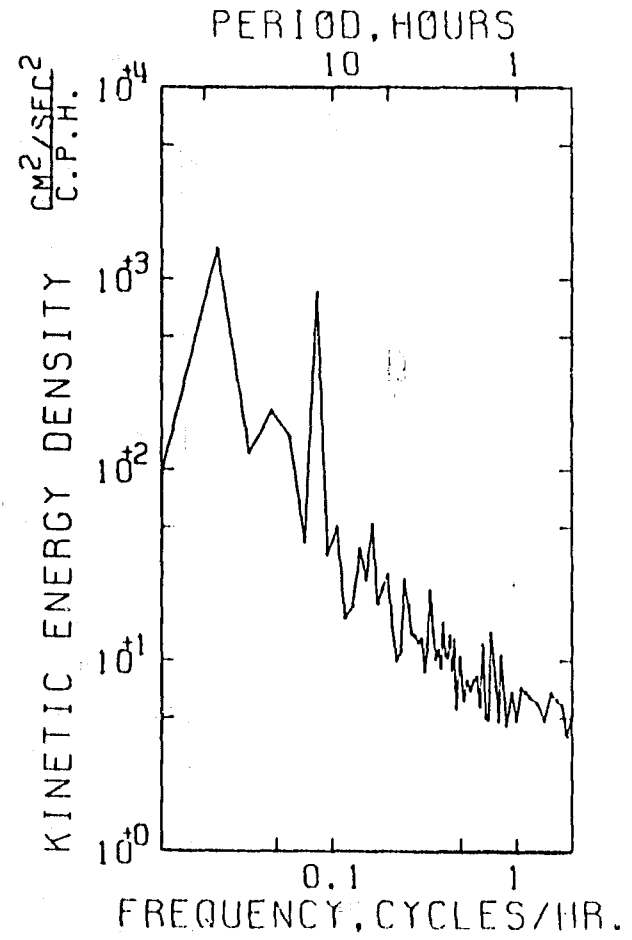

AK14A
 GEODYNE

TIME	DEPTH	TEMP	SPEED
2100	100	10.0	0.0
2105	100	10.0	0.0
2110	100	10.0	0.0
2115	100	10.0	0.0
2120	100	10.0	0.0
2125	100	10.0	0.0
2130	100	10.0	0.0
2135	100	10.0	0.0
2140	100	10.0	0.0
2145	100	10.0	0.0
2150	100	10.0	0.0
2155	100	10.0	0.0
2200	100	10.0	0.0
2205	100	10.0	0.0
2210	100	10.0	0.0
2215	100	10.0	0.0
2220	100	10.0	0.0
2225	100	10.0	0.0
2230	100	10.0	0.0
2235	100	10.0	0.0
2240	100	10.0	0.0
2245	100	10.0	0.0
2250	100	10.0	0.0
2255	100	10.0	0.0
2300	100	10.0	0.0
2305	100	10.0	0.0
2310	100	10.0	0.0
2315	100	10.0	0.0
2320	100	10.0	0.0
2325	100	10.0	0.0
2330	100	10.0	0.0
2335	100	10.0	0.0
2340	100	10.0	0.0
2345	100	10.0	0.0
2350	100	10.0	0.0
2355	100	10.0	0.0
2400	100	10.0	0.0
2405	100	10.0	0.0
2410	100	10.0	0.0
2415	100	10.0	0.0
2420	100	10.0	0.0
2425	100	10.0	0.0
2430	100	10.0	0.0
2435	100	10.0	0.0
2440	100	10.0	0.0
2445	100	10.0	0.0
2450	100	10.0	0.0
2455	100	10.0	0.0
2500	100	10.0	0.0
2505	100	10.0	0.0
2510	100	10.0	0.0
2515	100	10.0	0.0
2520	100	10.0	0.0
2525	100	10.0	0.0
2530	100	10.0	0.0
2535	100	10.0	0.0
2540	100	10.0	0.0
2545	100	10.0	0.0
2550	100	10.0	0.0
2555	100	10.0	0.0
2600	100	10.0	0.0
2605	100	10.0	0.0
2610	100	10.0	0.0
2615	100	10.0	0.0
2620	100	10.0	0.0
2625	100	10.0	0.0
2630	100	10.0	0.0
2635	100	10.0	0.0
2640	100	10.0	0.0
2645	100	10.0	0.0
2650	100	10.0	0.0
2655	100	10.0	0.0
2700	100	10.0	0.0
2705	100	10.0	0.0
2710	100	10.0	0.0
2715	100	10.0	0.0
2720	100	10.0	0.0
2725	100	10.0	0.0
2730	100	10.0	0.0
2735	100	10.0	0.0
2740	100	10.0	0.0
2745	100	10.0	0.0
2750	100	10.0	0.0
2755	100	10.0	0.0
2800	100	10.0	0.0
2805	100	10.0	0.0
2810	100	10.0	0.0
2815	100	10.0	0.0
2820	100	10.0	0.0
2825	100	10.0	0.0
2830	100	10.0	0.0
2835	100	10.0	0.0
2840	100	10.0	0.0
2845	100	10.0	0.0
2850	100	10.0	0.0
2855	100	10.0	0.0
2900	100	10.0	0.0
2905	100	10.0	0.0
2910	100	10.0	0.0
2915	100	10.0	0.0
2920	100	10.0	0.0
2925	100	10.0	0.0
2930	100	10.0	0.0
2935	100	10.0	0.0
2940	100	10.0	0.0
2945	100	10.0	0.0
2950	100	10.0	0.0
2955	100	10.0	0.0
3000	100	10.0	0.0

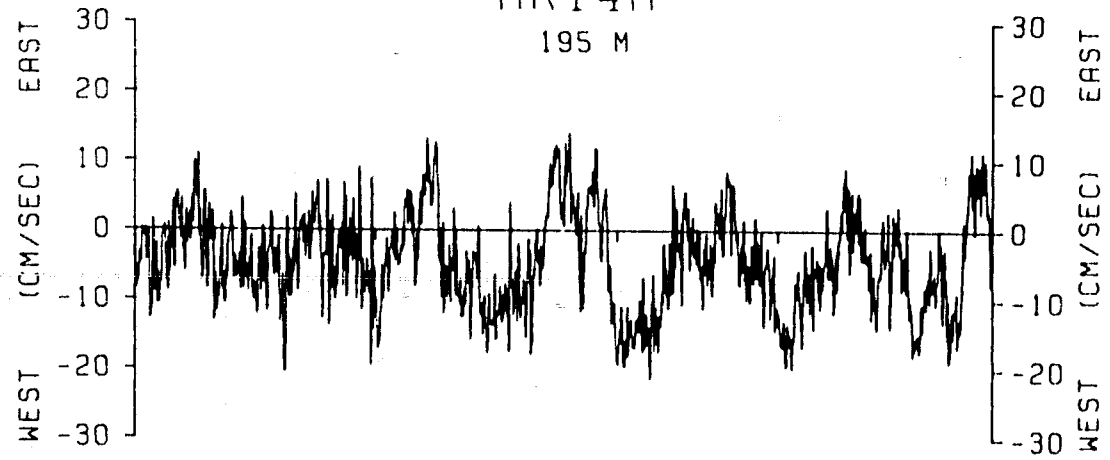
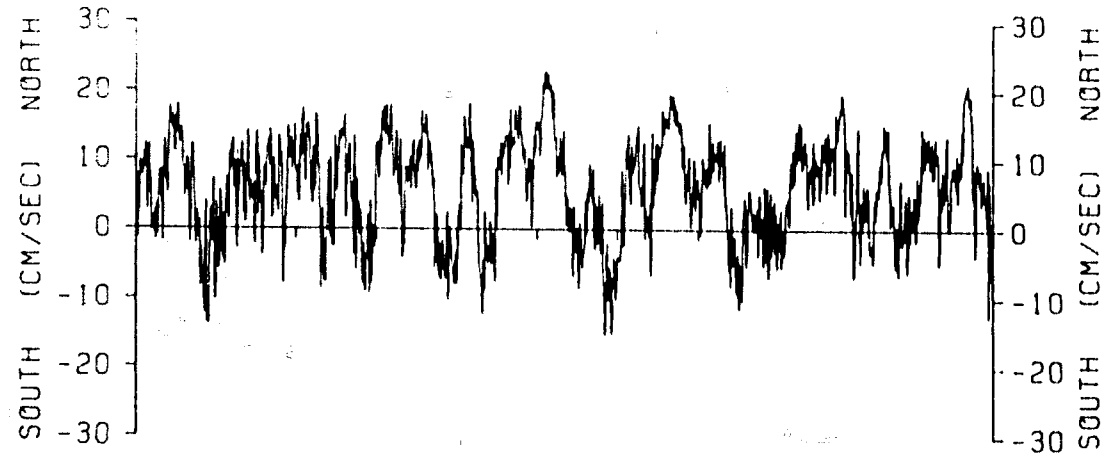

AK 14A
GEODYNE

STATS

E = EAST
N = NORTH
UNITS = MM/SEC
UNITS = MM/SEC

DATE	HR	MIN	SEC	MEAN (E)	MEAN (N)	VECTOR MEAN	VARIANCE (E)	VARIANCE (N)	VECTOR VARIANCE	COVARIANCE (E N)	MEAN (E)	VARIANCE (E)
70-111-22	12	0	3	-23	65	69	3008.20	8055.04	5761.44	112.23	105	5168.69
70-111-23	12	0	3	-71	72	102	5536.65	7230.69	6385.66	-506.21	131	8000.51
70-111-24	12	0	3	-20	67	73	4311.42	9513.63	7927.32	3327.49	120	8321.66
70-111-25	12	0	3	-17	97	38	9608.69	11830.75	10700.72	882.24	154	6177.65
70-111-26	12	0	3	-129	137	188	5700.22	13642.66	9691.24	2601.66	160	13102.00
70-111-27	12	0	3	6	65	86	12335.51	21993.39	17160.45	7370.45	200	9325.94
70-111-28	12	0	3	-141	140	199	16500.70	10433.16	13489.03	3620.38	222	3512.92
70-111-29	12	0	3	-62	28	64	5810.65	7872.48	6891.56	1765.93	212	6626.91
70-111-30	12	0	3	-99	142	174	13070.39	8011.66	10700.32	2279.29	156	7751.25
70-111-31	12	0	3	-101	71	124	8718.01	8207.93	8463.17	-1323.81	181	11005.63
70-IV-1	12	3	3	-55	87	103	12092.68	11702.56	11897.62	1227.81		

SPEED
UNITS = MM/SEC



0 30
KILOMETERS

AK15

200 M
70-111-20 TO 70-IV-02

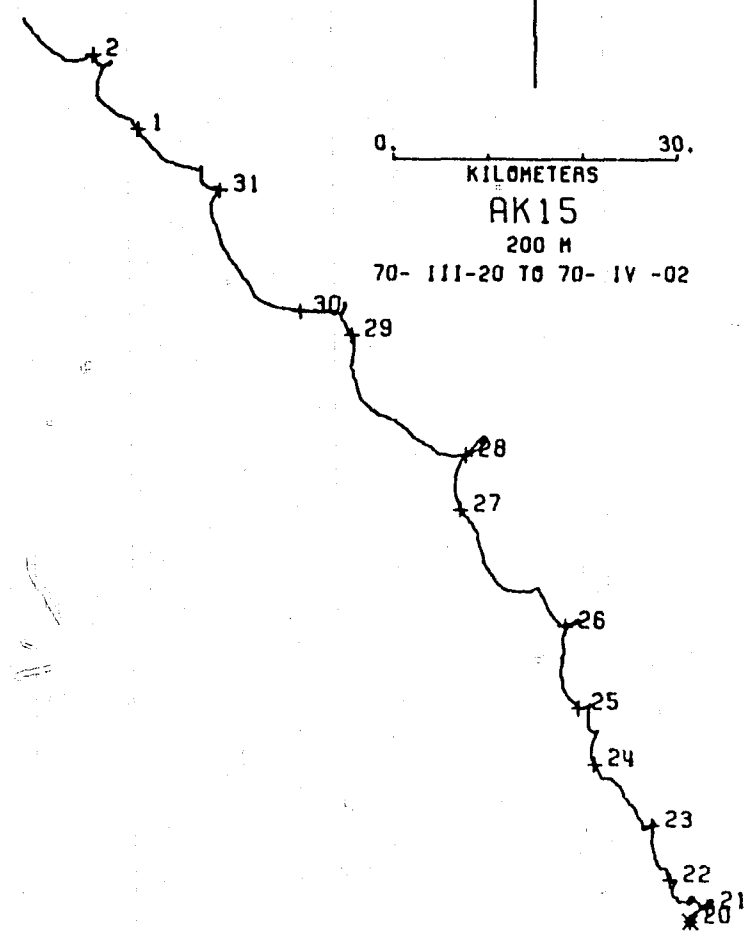

STATS

*** EAST ***
*** MM/SEC ***

MEAN = -66.78 STD ERR = 3.34
VARIANCE = 11392.16
STD DEV = 106.73
KURTOSIS = 2.04
SKEWNESS = -0.222

*** NORTH ***
*** MM/SEC ***

MEAN = 90.14 STD ERR = 3.04
VARIANCE = 12149.39
STD DEV = 110.22
KURTOSIS = 2.60
SKEWNESS = 0.199

*** SPEED ***
*** MM/SEC ***

MEAN = 163.26 STD ERR = 3.00
VARIANCE = 9209.28
STD DEV = 95.97
KURTOSIS = 2.15
SKEWNESS = 0.260

*** EAST & NORTH ***
*** MM/SEC ***

COVARIANCE = 910.26 STD ERR = 537.69
STD DEV OF COVARIANCE = 17193.42
CORRELATION COEFFICIENT = 0.777

***** VECTOR PLANS *****
***** EAST & NORTH *****

MEAN = 111.00
VARIANCE = 11770.77
STD DEV = 108.49

SAMPLE SIZE = 1024 PRINTS

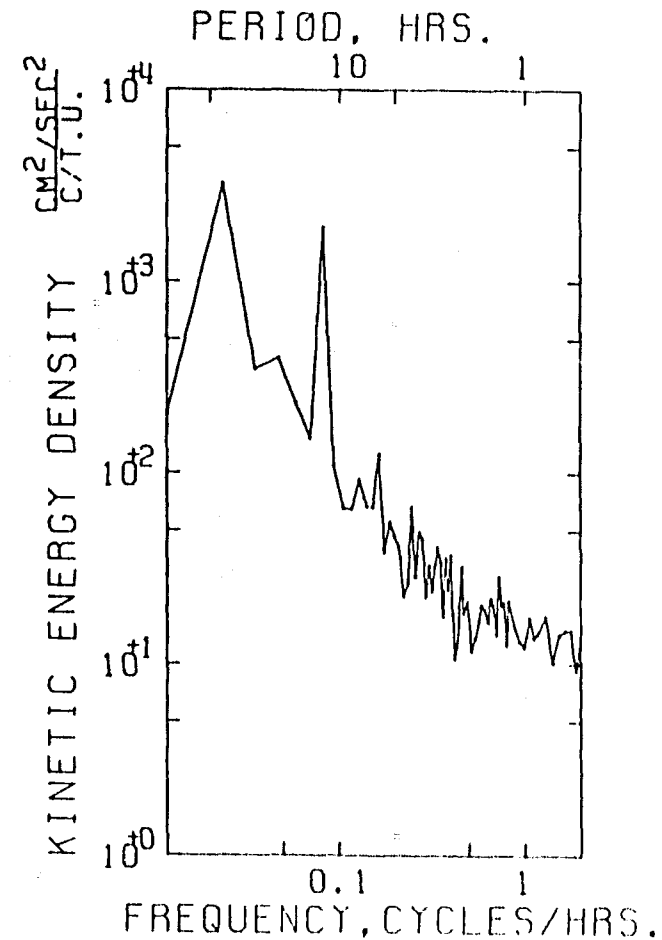

AK 15
ALEXAEV

TIME 15704411 DATE 0415 PLTFILE BEGIN/70-111423 151500

TIME	DEPTH	TEMP	SPEED
201000	3	54.3	3.3
201100	3	54.3	3.3
201200	3	54.3	3.3
201300	3	54.3	3.3
201400	3	54.3	3.3
201500	3	54.3	3.3
201600	3	54.3	3.3
201700	3	54.3	3.3
201800	3	54.3	3.3
201900	3	54.3	3.3
202000	3	54.3	3.3
202100	3	54.3	3.3
202200	3	54.3	3.3
202300	3	54.3	3.3
202400	3	54.3	3.3
202500	3	54.3	3.3
202600	3	54.3	3.3
202700	3	54.3	3.3
202800	3	54.3	3.3
202900	3	54.3	3.3
203000	3	54.3	3.3
203100	3	54.3	3.3
203200	3	54.3	3.3
203300	3	54.3	3.3
203400	3	54.3	3.3
203500	3	54.3	3.3
203600	3	54.3	3.3
203700	3	54.3	3.3
203800	3	54.3	3.3
203900	3	54.3	3.3
204000	3	54.3	3.3
204100	3	54.3	3.3
204200	3	54.3	3.3
204300	3	54.3	3.3
204400	3	54.3	3.3
204500	3	54.3	3.3
204600	3	54.3	3.3
204700	3	54.3	3.3
204800	3	54.3	3.3
204900	3	54.3	3.3
205000	3	54.3	3.3
205100	3	54.3	3.3
205200	3	54.3	3.3
205300	3	54.3	3.3
205400	3	54.3	3.3
205500	3	54.3	3.3
205600	3	54.3	3.3
205700	3	54.3	3.3
205800	3	54.3	3.3
205900	3	54.3	3.3
206000	3	54.3	3.3
206100	3	54.3	3.3
206200	3	54.3	3.3
206300	3	54.3	3.3
206400	3	54.3	3.3
206500	3	54.3	3.3
206600	3	54.3	3.3
206700	3	54.3	3.3
206800	3	54.3	3.3
206900	3	54.3	3.3
207000	3	54.3	3.3
207100	3	54.3	3.3
207200	3	54.3	3.3
207300	3	54.3	3.3
207400	3	54.3	3.3
207500	3	54.3	3.3
207600	3	54.3	3.3
207700	3	54.3	3.3
207800	3	54.3	3.3
207900	3	54.3	3.3
208000	3	54.3	3.3
208100	3	54.3	3.3
208200	3	54.3	3.3
208300	3	54.3	3.3
208400	3	54.3	3.3
208500	3	54.3	3.3
208600	3	54.3	3.3
208700	3	54.3	3.3
208800	3	54.3	3.3
208900	3	54.3	3.3
209000	3	54.3	3.3
209100	3	54.3	3.3
209200	3	54.3	3.3
209300	3	54.3	3.3
209400	3	54.3	3.3
209500	3	54.3	3.3
209600	3	54.3	3.3
209700	3	54.3	3.3
209800	3	54.3	3.3
209900	3	54.3	3.3
210000	3	54.3	3.3

DATAZ 0415
 SAMPLE SIZE = 10000000 SECONDS
 SPANNING RANGE
 FROM 70-111423 151500
 TO 70-111423 151500
 OPERATE COPY LENGTH/SAMPLE = 10
 TOTAL NUMBER OF DATA SAMPLES = 100
 NUMBER OF VALID DATA SAMPLES = 0

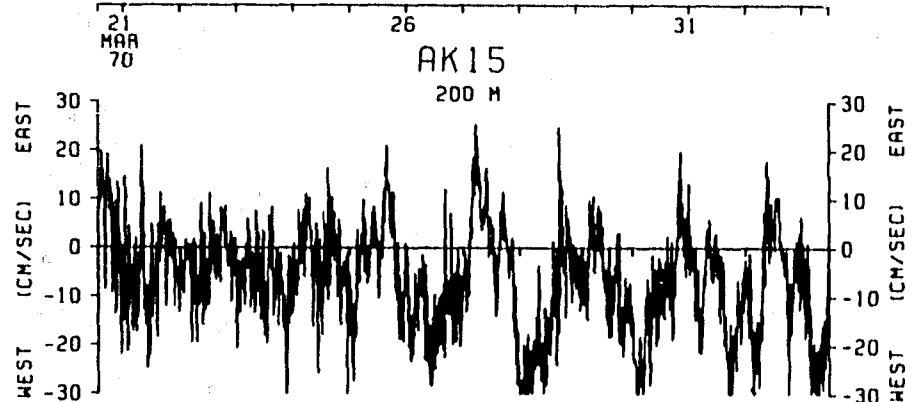
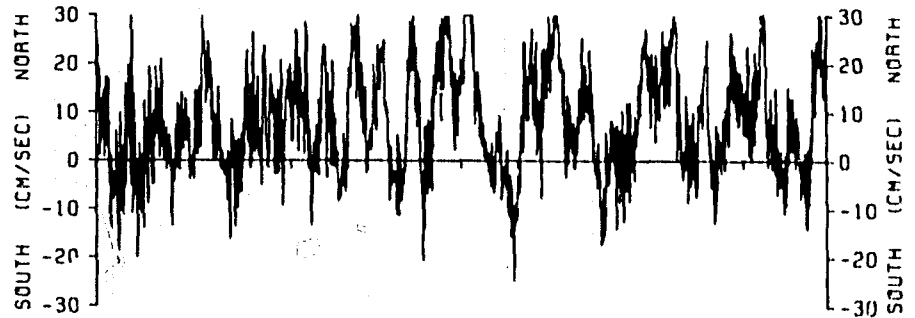

AK15
 ALEXAEV

STATS

E = EAST
N = NORTH

UNITS = MM/SEC
UNITS = MM/SEC

DATE	MID TIME		MEAN		VECTOR MEAN	VARIANCE (E)	VARIANCE (N)	VECTOR VARIANCE	COVARIANCE (E N)	SPEED		
	HR	MIN	SEC	(E)						(N)	UNITS = MM/SEC	UNITS = MM/SEC
70- 111-22	12	0	0	-56.	151.	161.	1225.45	8119.99	4672.72	-2811.59	197.	319.76
70- 111-23	12	0	0	1.	-36.	36.	6636.75	35036.99	20835.87	-12626.76	199.	532.92
70- 111-24	12	0	0	67.	-149.	152.	1547.22	3513.94	3530.58	-2226.67	200.	444.85
70- 111-25	12	0	0	44.	-125.	133.	421.75	1432.52	927.14	-701.93	190.	620.44
70- 111-26	12	0	0	47.	-135.	143.	365.75	1883.60	112.68	-679.62	150.	581.91
70- 111-27	12	0	0	53.	-160.	168.	1311.15	3044.46	2187.80	-1601.33	143.	323.89
70- 111-28	12	0	0	56.	-160.	169.	577.20	1022.91	800.05	-711.52	165.	554.67
70- 111-29	12	0	0	47.	-131.	139.	139.22	1087.40	613.31	-389.08	180.	372.11
70- 111-30	12	0	0	46.	-129.	137.	153.12	1196.03	674.58	-427.95	159.	548.10
70- 111-31	12	0	0	44.	-124.	133.	284.46	1431.05	857.75	-619.83	129.	270.60
70- IV - 1	12	0	0	56.	-160.	170.	86.24	334.88	210.56	-75.49	144.	488.18

STATS

MEAN = 0.000
VARIANCE = 22000.0
STD. DEV. = 148.3
KURT. SIG. = 7.00
SAFE. ELS = 0.16

MEAN = 10.000
VARIANCE = 1390.00
STD. DEV. = 37.30
KURT. SIG. = 0.00
SAFE. ELS = 1.47

MEAN = 10.000
VARIANCE = 10.000
STD. DEV. = 3.16
KURT. SIG. = 0.00
SAFE. ELS = 0.00

COVARIANCE = 0.000
STD. DEV. = 0.000
CORRELATION COEFFICIENT = 0.000

MEAN = 0.000
VARIANCE = 0.000
STD. DEV. = 0.000

MEAN = 0.000
VARIANCE = 0.000
STD. DEV. = 0.000

SAFE. ELS = 0.000

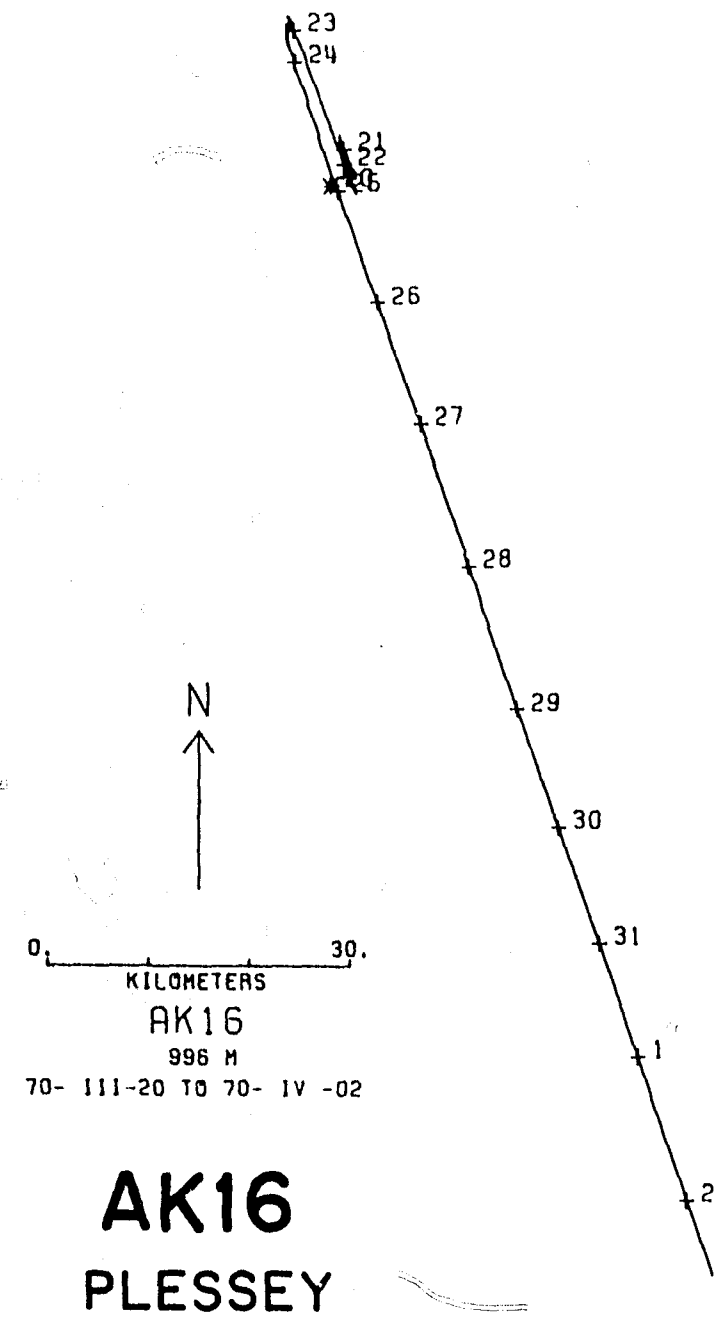
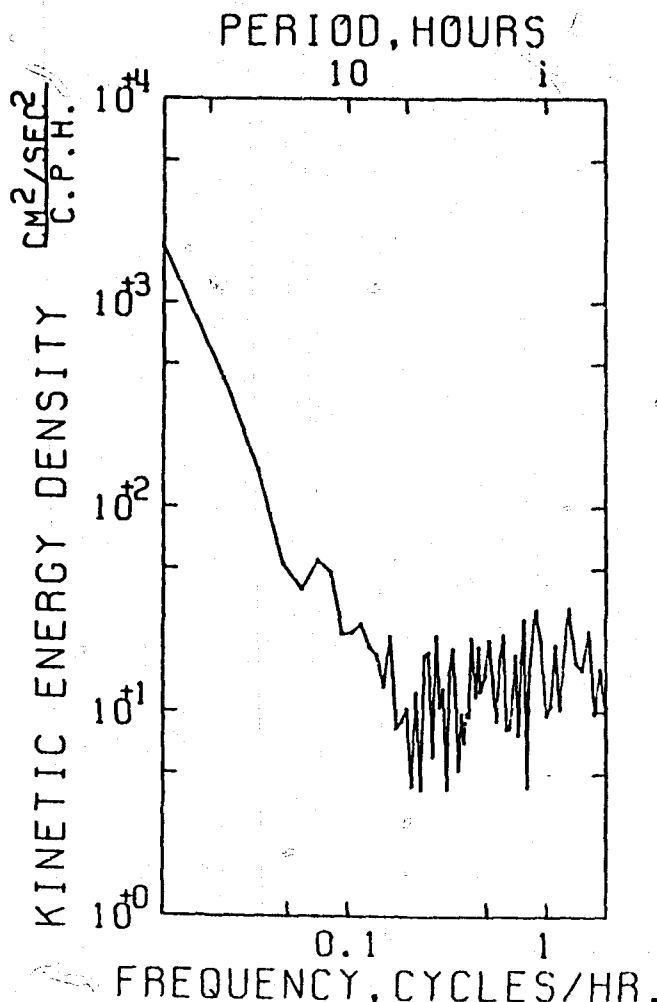

STATS

E = EAST
N = NORTH

UNITS = MM/SEC
UNITS = MM/SEC

DATE	MID TIME			MEAN (E)	MEAN (N)	VECTOR MEAN	VARIANCE (E)	VARIANCE (N)	VECTOR VARIANCE	COVARIANCE (E S N)	SPEED	
	HR	MIN	SEC								UNITS (E)	UNITS (N)
70-111-22	12	0	0	6	10	12	1403.38	2164.26	1783.82	512.79	53	867.70
70-111-23	12	0	0	-10	23	25	2966.99	3415.23	3191.10	-144.12	78	989.58
70-111-24	12	0	0	-20	31	36	3302.40	2596.55	2949.47	-151.80	75	1062.33
70-111-25	12	0	0	-13	22	25	2219.61	1493.24	1856.43	585.27	59	871.43
70-111-27	12	0	0	-11	31	33	2477.70	2229.00	2353.35	124.98	69	1017.18
70-111-28	12	0	0	-10	26	28	1370.08	1608.88	1489.47	95.76	57	555.20
70-111-29	12	0	0	-18	28	32	1961.40	2109.92	2335.66	-866.80	63	1197.75
70-111-30	12	0	0	-9	34	34	1549.31	2406.92	1988.11	-1.13	66	782.25
70-111-31	12	0	0	-27	37	46	1370.63	2991.63	2181.13	-268.40	71	1405.98
70-IV-1	12	0	0	-15	28	37	2021.45	3679.13	3150.29	232.92	83	793.13
					39	42	3002.05	3575.99	3289.02	-454.04	98	1319.31

STATS

*** EAST ***
*** MM/SEC ***

MEAN = -14.13
VARIANCE = 2284.63
STD. DEV. = 47.84
KURTOSIS = 2.72
SKEWNESS = 0.190
STD ERR = 1.09

*** NORTH ***
*** MM/SEC ***

MEAN = 28.66
VARIANCE = 2650.13
STD. DEV. = 51.48
KURTOSIS = 2.62
SKEWNESS = -0.017
STD ERR = 1.01

*** SPEED ***
*** MM/SEC ***

MEAN = 69.24
VARIANCE = 1164.85
STD. DEV. = 34.13
KURTOSIS = 2.77
SKEWNESS = 0.473
STD ERR = 1.07

*** EAST & NORTH ***
*** MM/SEC ***

COVARIANCE = -55.56
STD. DEV. OF COVARIANCE = 2935.41
CORRELATION COEFFICIENT = -0.223
STD ERR = 91.03

***** VECTOR MEANS *****
***** EAST & NORTH *****

MEAN = 71.94
VARIANCE = 2459.35
STD. DEV. = 49.69

SAMPLE SIZE = 102 POINTS



0 30
KILOMETERS

AK17

1000 M

70-111-20 TO 70-IV-02

CM²/SEC²
C.P.H.

KINETIC ENERGY DENSITY

PERIOD, HOURS

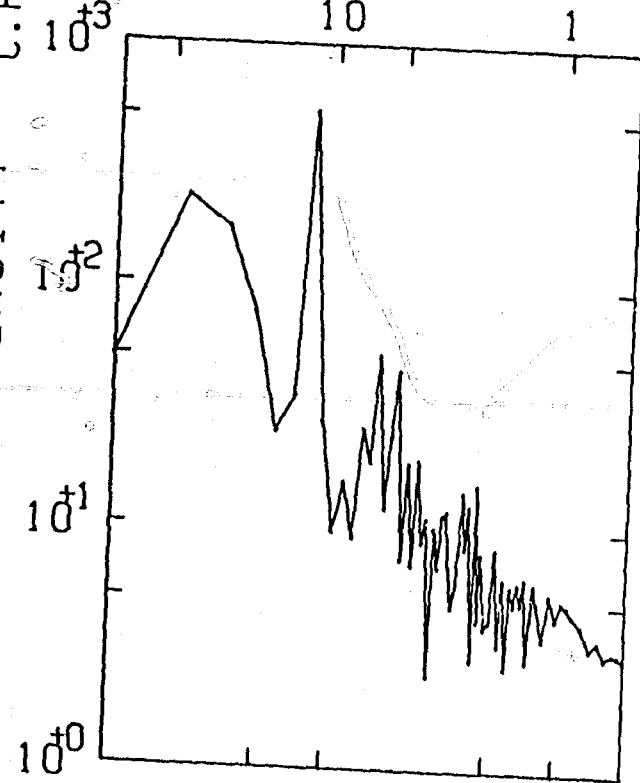

0.1 1
FREQUENCY, CYCLES/HR.

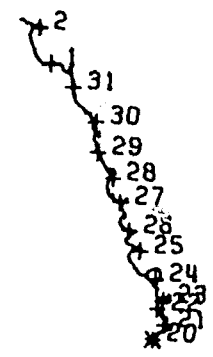

AK17
ALEXAEV

TIME - 15:00:00 DATE 04/17 PLUTONIA BEGINS/ TO: 11:00 15:00

TIME	SPD	DIR	SPD	DIR	SPD	DIR
20:00	1.0	100	1.0	100	1.0	100
20:05	1.0	100	1.0	100	1.0	100
20:10	1.0	100	1.0	100	1.0	100
20:15	1.0	100	1.0	100	1.0	100
20:20	1.0	100	1.0	100	1.0	100
20:25	1.0	100	1.0	100	1.0	100
20:30	1.0	100	1.0	100	1.0	100
20:35	1.0	100	1.0	100	1.0	100
20:40	1.0	100	1.0	100	1.0	100
20:45	1.0	100	1.0	100	1.0	100
20:50	1.0	100	1.0	100	1.0	100
20:55	1.0	100	1.0	100	1.0	100
21:00	1.0	100	1.0	100	1.0	100
21:05	1.0	100	1.0	100	1.0	100
21:10	1.0	100	1.0	100	1.0	100
21:15	1.0	100	1.0	100	1.0	100
21:20	1.0	100	1.0	100	1.0	100
21:25	1.0	100	1.0	100	1.0	100
21:30	1.0	100	1.0	100	1.0	100
21:35	1.0	100	1.0	100	1.0	100
21:40	1.0	100	1.0	100	1.0	100
21:45	1.0	100	1.0	100	1.0	100
21:50	1.0	100	1.0	100	1.0	100
21:55	1.0	100	1.0	100	1.0	100
22:00	1.0	100	1.0	100	1.0	100
22:05	1.0	100	1.0	100	1.0	100
22:10	1.0	100	1.0	100	1.0	100
22:15	1.0	100	1.0	100	1.0	100
22:20	1.0	100	1.0	100	1.0	100
22:25	1.0	100	1.0	100	1.0	100
22:30	1.0	100	1.0	100	1.0	100
22:35	1.0	100	1.0	100	1.0	100
22:40	1.0	100	1.0	100	1.0	100
22:45	1.0	100	1.0	100	1.0	100
22:50	1.0	100	1.0	100	1.0	100
22:55	1.0	100	1.0	100	1.0	100
23:00	1.0	100	1.0	100	1.0	100
23:05	1.0	100	1.0	100	1.0	100
23:10	1.0	100	1.0	100	1.0	100
23:15	1.0	100	1.0	100	1.0	100
23:20	1.0	100	1.0	100	1.0	100
23:25	1.0	100	1.0	100	1.0	100
23:30	1.0	100	1.0	100	1.0	100
23:35	1.0	100	1.0	100	1.0	100
23:40	1.0	100	1.0	100	1.0	100
23:45	1.0	100	1.0	100	1.0	100
23:50	1.0	100	1.0	100	1.0	100
23:55	1.0	100	1.0	100	1.0	100
00:00	1.0	100	1.0	100	1.0	100

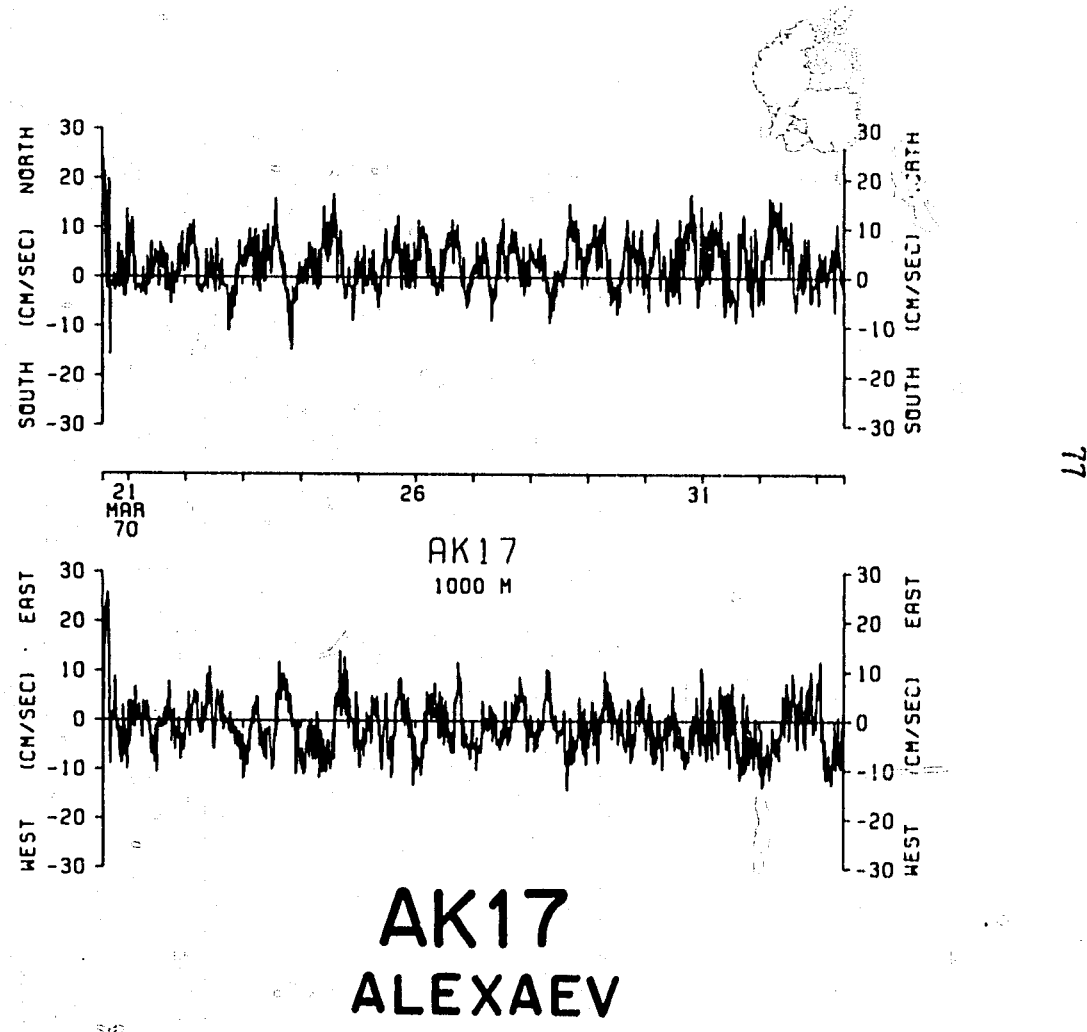

STATS

E = EAST
N = NORTH

UNITS = MM/SEC
UNITS = MM/SEC

DATE	MID TIME			MEAN (E)	MEAN (N)	VECTOR MEAN	VARIANCE (E)	VARIANCE (N)	VECTOR VARIANCE (E & N)	COVARIANCE (E & N)	SPEED	
	HR	MIN	SEC								UNITS = MM/SEC	UNITS = MM/SEC
70- 111-22	12	0	1	-182.	38.	186.	6485.47	24067.58	19276.52	3307.66	252.	1339.81
70- 111-23	12	0	1	-132.	102.	167.	17596.10	26218.06	71907.08	10377.59	266.	965.62
70- 111-24	12	0	1	-114.	123.	168.	18448.23	15968.66	17308.67	7730.44	248.	1380.28
70- 111-25	12	0	1	-111.	114.	159.	9966.81	12984.03	11475.42	3660.20	215.	1822.98
70- 111-26	12	0	1	-179.	156.	237.	1413.20	3052.17	2232.69	451.33	244.	943.97
70- 111-27	12	0	1	-199.	153.	251.	7048.4.	15461.65	12255.03	3929.56	291.	2396.66
70- 111-28	12	0	1	-193.	174.	260.	14112.44	19125.66	16619.05	10092.26	312.	3190.18
70- 111-29	12	0	1	-209.	177.	222.	6578.87	21467.24	14013.05	3863.97	275.	1980.11
70- 111-30	12	0	1	-117.	183.	217.	21517.28	10629.36	16073.32	2014.66	268.	7153.38
70- 111-31	12	0	1	-100.	91.	135.	13885.54	12846.28	13365.91	2713.59	208.	1402.64
70- IV - 1	12	0	1	-37.	212.	38.	17206.95	15108.22	16157.58	-582.03	186.	1060.11

STATS

*** EAST ***
*** MM/SEC ***
MEAN = -107.42
VARIANCE = 14203.79
STD. DEV. = 119.35
KURTOSIS = 3.48
SKEWNESS = 0.391

37 ERR = 3.73

*** NORTH ***
*** MM/SEC ***
MEAN = 116.29
VARIANCE = 18101.54
STD. DEV. = 134.54
KURTOSIS = 2.79
SKEWNESS = -0.743

STD. ERR = 4.20

*** SPEED ***
*** MM/SEC ***
MEAN = 253.56
VARIANCE = 3366.87
STD. DEV. = 58.02
KURTOSIS = 3.16
SKEWNESS = 0.394

STD. ERR = 1.81

*** EAST & NORTH ***
*** MM/SEC ***
COVARIANCE = 4155.4
STD. DEV. OF COVARIANCE = 25173.05
CORRELATION COEFFICIENT = 0.259

780.56

***** VECTOR MEANS *****
***** EAST & NORTH *****

MEAN = 137.93
VARIANCE = 16172.65
STD. DEV. = 127.17

SAMPLE SIZE = 102 POINTS

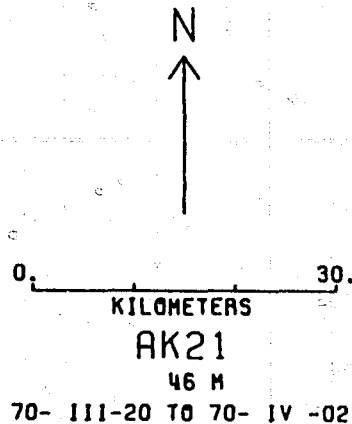

KINETIC ENERGY DENSITY CM²/SEC² / C.P.H.

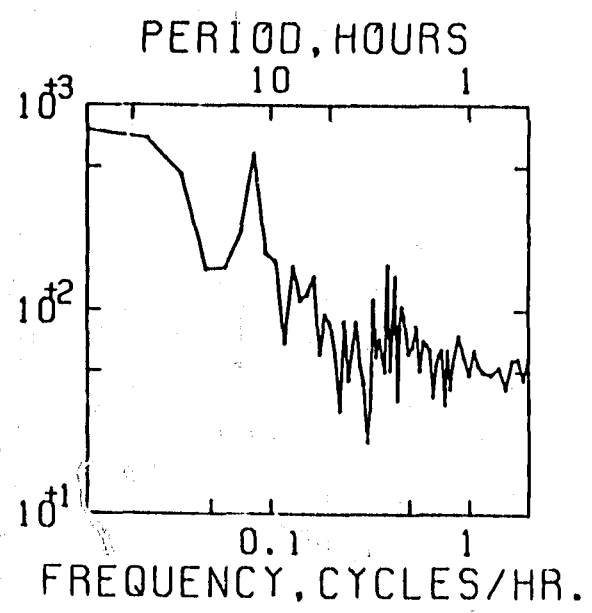

**AK21
PLESSEY**

PLESTYNA BEFANSY 70- 211-21 33-00-00
 711-21 0 310-0 2
 711-22 0 311-0 6
 711-23 33 00-0 33
 711-24 2 0 22 2 2
 711-25 0 0 0 0 0
 711-26 3 0 0 0 0
 711-27 0 0 0 0 0
 711-28 0 0 0 0 0
 711-29 0 0 0 0 0
 711-30 0 0 0 0 0
 711-31 0 0 0 0 0
 711-32 0 0 0 0 0
 711-33 0 0 0 0 0
 711-34 0 0 0 0 0
 711-35 0 0 0 0 0
 711-36 0 0 0 0 0
 711-37 0 0 0 0 0
 711-38 0 0 0 0 0
 711-39 0 0 0 0 0
 711-40 0 0 0 0 0
 711-41 0 0 0 0 0
 711-42 0 0 0 0 0
 711-43 0 0 0 0 0
 711-44 0 0 0 0 0
 711-45 0 0 0 0 0
 711-46 0 0 0 0 0
 711-47 0 0 0 0 0
 711-48 0 0 0 0 0
 711-49 0 0 0 0 0
 711-50 0 0 0 0 0
 711-51 0 0 0 0 0
 711-52 0 0 0 0 0
 711-53 0 0 0 0 0
 711-54 0 0 0 0 0
 711-55 0 0 0 0 0
 711-56 0 0 0 0 0
 711-57 0 0 0 0 0
 711-58 0 0 0 0 0
 711-59 0 0 0 0 0
 711-60 0 0 0 0 0
 711-61 0 0 0 0 0
 711-62 0 0 0 0 0
 711-63 0 0 0 0 0
 711-64 0 0 0 0 0
 711-65 0 0 0 0 0
 711-66 0 0 0 0 0
 711-67 0 0 0 0 0
 711-68 0 0 0 0 0
 711-69 0 0 0 0 0
 711-70 0 0 0 0 0
 711-71 0 0 0 0 0
 711-72 0 0 0 0 0
 711-73 0 0 0 0 0
 711-74 0 0 0 0 0
 711-75 0 0 0 0 0
 711-76 0 0 0 0 0
 711-77 0 0 0 0 0
 711-78 0 0 0 0 0
 711-79 0 0 0 0 0
 711-80 0 0 0 0 0
 711-81 0 0 0 0 0
 711-82 0 0 0 0 0
 711-83 0 0 0 0 0
 711-84 0 0 0 0 0
 711-85 0 0 0 0 0
 711-86 0 0 0 0 0
 711-87 0 0 0 0 0
 711-88 0 0 0 0 0
 711-89 0 0 0 0 0
 711-90 0 0 0 0 0
 711-91 0 0 0 0 0
 711-92 0 0 0 0 0
 711-93 0 0 0 0 0
 711-94 0 0 0 0 0
 711-95 0 0 0 0 0
 711-96 0 0 0 0 0
 711-97 0 0 0 0 0
 711-98 0 0 0 0 0
 711-99 0 0 0 0 0
 711-00 0 0 0 0 0

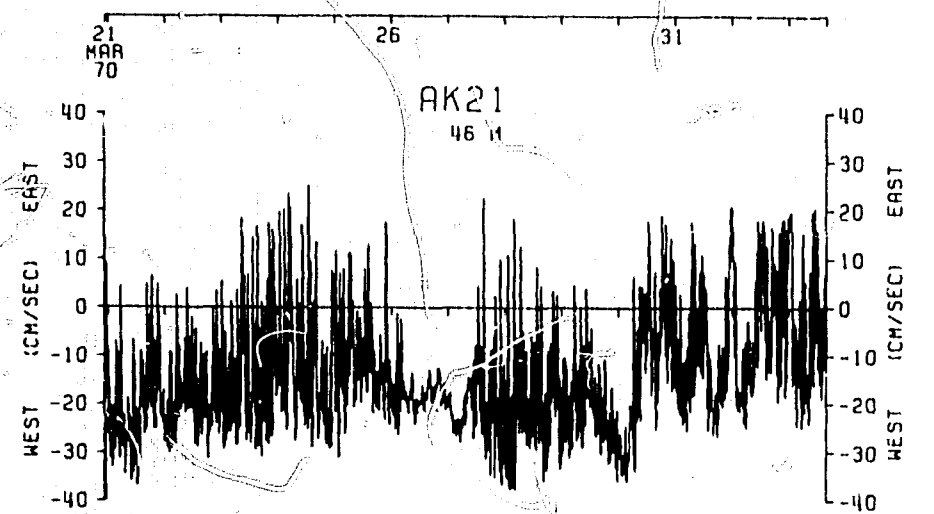
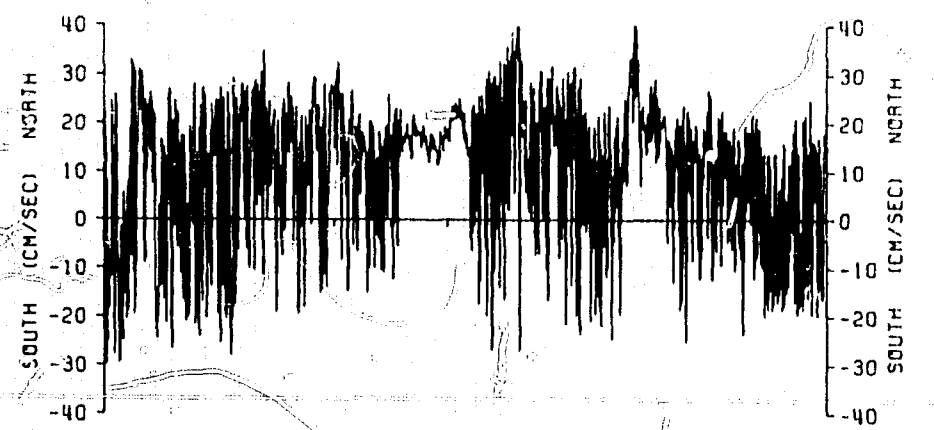

AK21
PLESSEY

DATA 4621
 SAMPLE 1000
 SPAN 1000
 PAGE 1
 TOTAL 1000
 MAP 1000

STATS

E = EAST
N = NORTH

UNITS = MM/SEC
UNITS = MM/SEC

DATE	MID TIME		MEAN		VECTOR		VARIANCE		VECTOR		COVARIANCE		SPEED		
	HR	MIN SEC	(E)	(N)	MEAN	(V)	(E)	(N)	VARIANCE	(E & N)	MEAN	VARIANCE	(E)	(N)	
70-111-22	12	0	0	-135.	140.	10463.72	13698.70	12084.21	3797.80	200.	3511.36	14182.87	3959.51	227.	4066.49
70-111-23	12	0	0	-140.	140.	10333.53	16332.22	12844.07	3223.49	231.	7235.15	12844.07	3223.49	231.	7235.15
70-111-24	12	0	0	-140.	140.	10392.16	15295.99	12844.07	3223.49	231.	7235.15	12844.07	3223.49	231.	7235.15
70-111-25	12	0	0	-100.	108.	8015.82	16483.66	12249.64	5583.43	200.	6080.11	12249.64	5583.43	200.	6080.11
70-111-26	12	0	0	-183.	120.	9022.68	12144.92	10578.80	4581.77	256.	3550.77	12144.92	4581.77	256.	3550.77
70-111-27	12	0	0	-229.	152.	17850.41	13038.56	15144.48	4193.74	313.	7905.63	15144.48	4193.74	313.	7905.63
70-111-28	12	0	0	-232.	192.	13793.21	12916.84	13355.02	3926.48	332.	7221.54	13355.02	3926.48	332.	7221.54
70-111-29	12	0	0	-248.	93.	10767.47	14929.33	12848.40	2264.51	300.	5794.78	12848.40	2264.51	300.	5794.78
70-111-30	12	0	0	-132.	176.	35442.71	12675.67	24559.19	4758.10	288.	13724.00	24559.19	4758.10	288.	13724.00
70-111-31	12	0	0	-111.	93.	18121.08	10329.35	16225.21	2263.48	209.	5561.19	16225.21	2263.48	209.	5561.19
70-IV-1	12	0	0	-28.	21.	12751.40	9771.84	11261.52	699.66	159.	2737.87	11261.52	699.66	159.	2737.87

STATS

*** EAST ***
*** MM/SEC ***

MEAN * -157.15 STD ERR * 0.20
VARIANCE * 18035.50
STD. DEV. * 134.30
KURTOSIS * 2.69
SKEWNESS * 0.293

*** NORTH ***
*** MM/SEC ***

MEAN * 113.10 STD ERR * 3.91
VARIANCE * 15640.82
STD. DEV. * 125.06
KURTOSIS * 2.88
SKEWNESS * -0.284

*** SPEED ***
*** MM/SEC ***

MEAN * 249.68 STD ERR * 2.94
VARIANCE * 8825.78
STD. DEV. * 93.95
KURTOSIS * 2.57
SKEWNESS * 0.378

*** EAST & NORTH ***
*** MM/SEC ***

COVARIANCE * 1524.21 STD ERR * 895.91
STD. DEV. OF COVARIANCE * 28463.09
CORRELATION COEFFICIENT * 0.091

***** VECTOR MEANS *****
***** EAST & NORTH *****

MEAN * 193.62
VARIANCE * 16838.15
STD. DEV. * 129.74

SAMPLE SIZE * 102 POINTS

KINETIC ENERGY DENSITY $\frac{CM^2}{SEC^2}$
C.P.H.

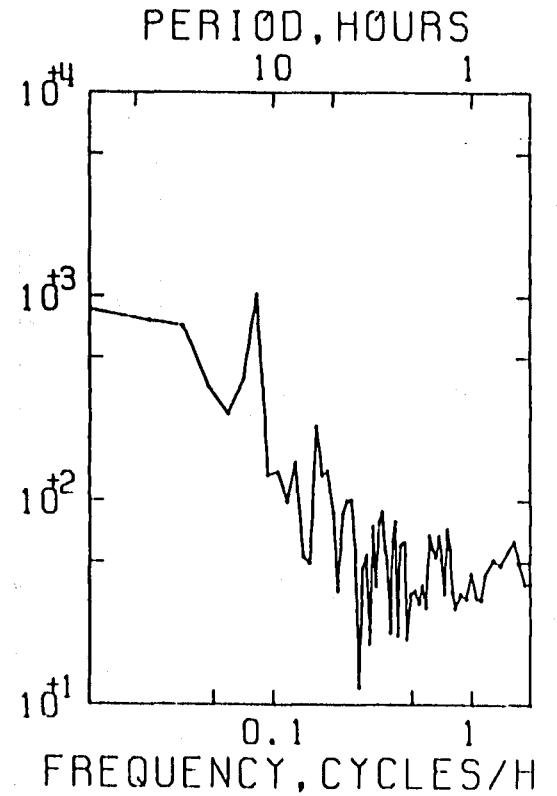

AK 22
ALEXAEV

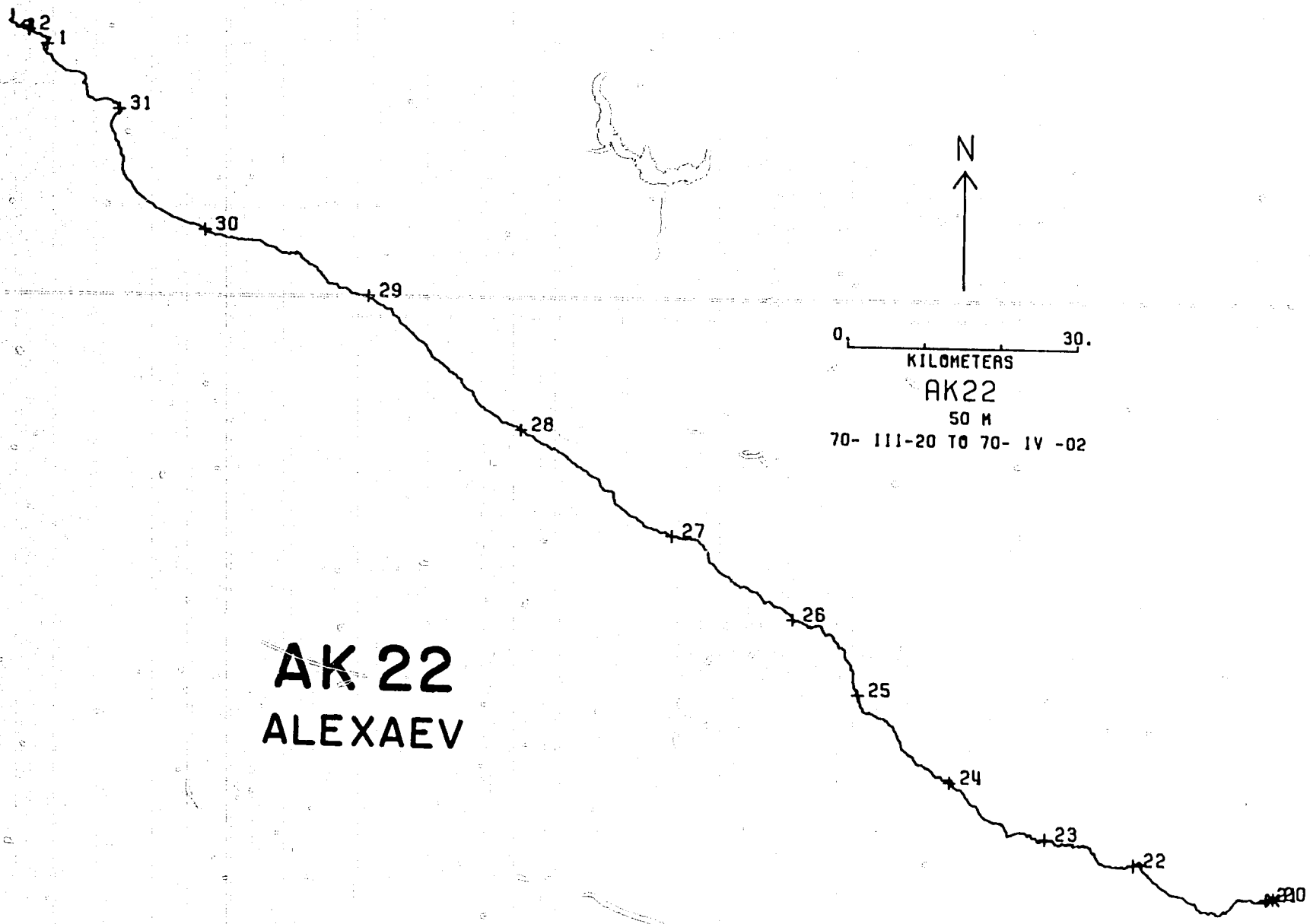

AK 22
ALEXAEV

0 30
KILOMETERS
AK 22
50 M
70- 111-20 TO 70- IV -02

TIME HISTOGRAM	DATA PAGE	PLOTTING BEGINS 70 MAR 21 02:30:00
.....
00	00	00
01	01	01
02	02	02
03	03	03
04	04	04
05	05	05
06	06	06
07	07	07
08	08	08
09	09	09
10	10	10
11	11	11
12	12	12
13	13	13
14	14	14
15	15	15
16	16	16
17	17	17
18	18	18
19	19	19
20	20	20
21	21	21
22	22	22
23	23	23
24	24	24
25	25	25
26	26	26
27	27	27
28	28	28
29	29	29
30	30	30
31	31	31
32	32	32
33	33	33
34	34	34
35	35	35
36	36	36
37	37	37
38	38	38
39	39	39
40	40	40
41	41	41
42	42	42
43	43	43
44	44	44
45	45	45
46	46	46
47	47	47
48	48	48
49	49	49
50	50	50
51	51	51
52	52	52
53	53	53
54	54	54
55	55	55
56	56	56
57	57	57
58	58	58
59	59	59
60	60	60
61	61	61
62	62	62
63	63	63
64	64	64
65	65	65
66	66	66
67	67	67
68	68	68
69	69	69
70	70	70
71	71	71
72	72	72
73	73	73
74	74	74
75	75	75
76	76	76
77	77	77
78	78	78
79	79	79
80	80	80
81	81	81
82	82	82
83	83	83
84	84	84
85	85	85
86	86	86
87	87	87
88	88	88
89	89	89
90	90	90
91	91	91
92	92	92
93	93	93
94	94	94
95	95	95
96	96	96
97	97	97
98	98	98
99	99	99
00	00	00

DATA 4472
 SAMPLE SIZE = 1000-000 1000US
 SPANNING RANGE
 FROM 70 MAR 21 02:30:00
 TO 70 MAR 21 02:35:00
 AVERAGE NUMBER ELEMENTS/SAMPLE = 12
 TOTAL NUMBER OF DATA SAMPLES = 103
 NUMBER OF PACKETS DATA SAMPLES = 70

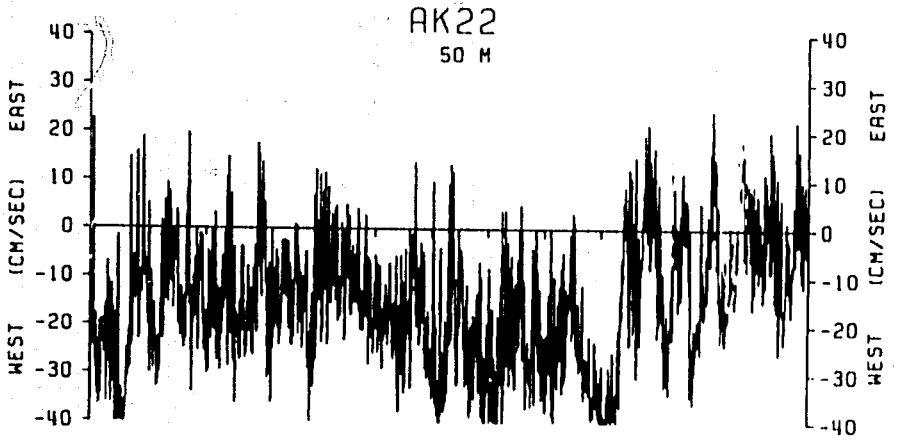
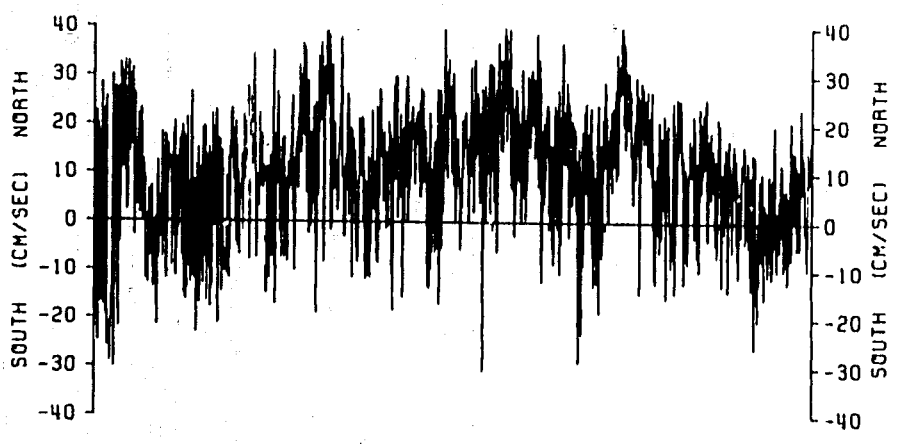

AK 22
 ALEXAEV

STATS

E = EAST UNITS = MM/SEC
 N = NORTH UNITS = MM/SEC

DATE	HR	MIN	SEC	MEAN (E)	MEAN (N)	VECTOR MEAN	VARIANCE (E)	VARIANCE (N)	VECTOR VARIANCE	COVARIANCE (E N)
70-111-22	12	0	0	-28.	42.	51.	9705.83	8052.12	8878.98	-814.88
70-111-23	12	0	0	-89.	8.	93.	4591.07	9464.15	7027.61	-2723.63
70-111-24	12	0	0	-22.	15.	27.	9328.92	8940.25	9154.59	333.58
70-111-25	12	0	0	-82.	69.	107.	3085.24	3265.34	3165.31	978.66
70-111-26	12	0	0	-61.	33.	70.	6753.73	6276.62	6515.17	155.46
70-111-27	12	0	0	-61.	63.	74.	6161.63	6815.12	6488.40	267.03
70-111-28	12	0	0	-70.	79.	105.	7451.82	3656.44	5554.13	483.72
70-111-29	12	0	0	-103.	16.	104.	3166.81	3289.07	3227.94	-7.75
70-111-30	12	0	0	-100.	64.	119.	1854.36	1463.08	1658.72	817.82
70-111-31	12	0	0	-102.	63.	111.	4443.93	2420.01	3421.97	720.98
70-IV-1	12	0	0	-69.	72.	100.	4232.87	5299.56	4766.21	810.05

STATS

*** EAST ***
 *** MM/SEC ***
 MEAN = -71.03 STD ERR = 2.49
 VARIANCE = 6342.52
 STD. DEV. = 79.64
 KURTOSIS = 3.59
 SKEWNESS = 1.103

*** NORTH ***
 *** MM/SEC ***
 MEAN = 43.62 STD ERR = 2.42
 VARIANCE = 5985.04
 STD. DEV. = 77.36
 KURTOSIS = 3.05
 SKEWNESS = -0.344

*** SPEED ***
 *** MM/SEC ***
 MEAN = 134.13 STD ERR = 0.45
 VARIANCE = 203.71
 STD. DEV. = 14.27
 KURTOSIS = 3.00
 SKEWNESS = .4693

*** EAST-NORTH ***
 *** MM/SEC ***
 COVARIANCE = -11426 STD ERR = 188.87
 STD. DEV. OF COVARIANCE = 6343.79
 CORRELATION COEFFICIENT = -0.002

***** VECTOR MEANS *****
 ***** EAST, NORTH *****

MEAN = 13.31
 VARIANCE = 41.677
 STD. DEV. = 6.478

SAMPLE SIZE = 1.20 POINTS

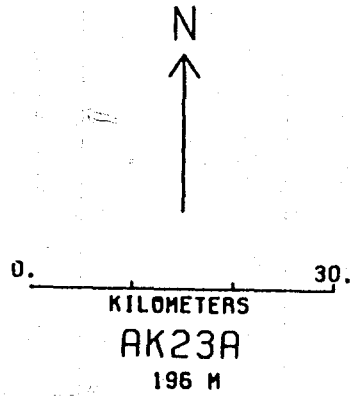

70-111-20 TO 70-IV-02

PERIOD, HOURS

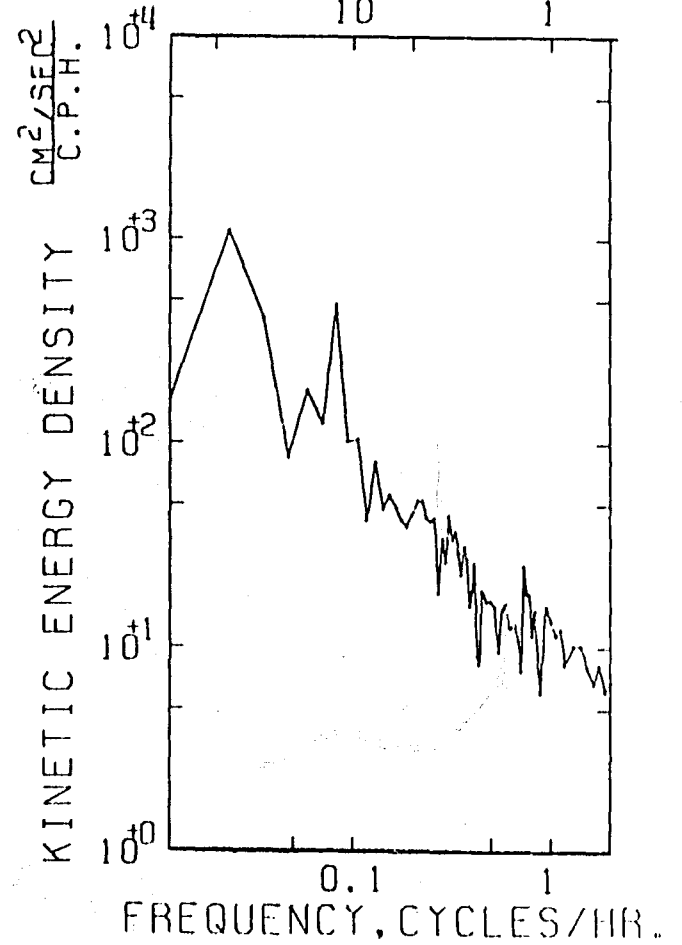

AK23A
 BRAINCON

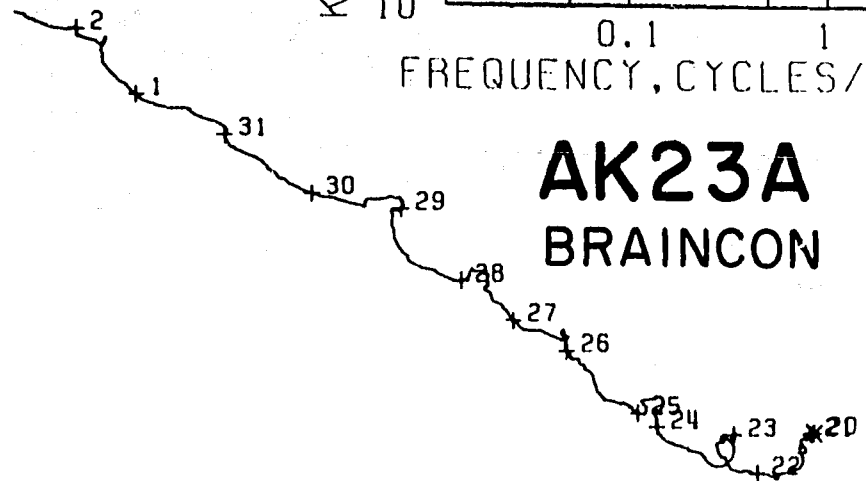



KILOMETERS

AK24

200 M

70- 111-20 TO 70- 111-24

AK 24
ALEXAEV

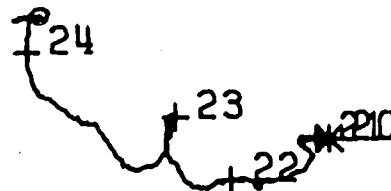

TIME HISTOGRAM

DATA/ AK24

PLOTTING BEGINS/ 70- III-21 03:30:00

DIRECTION DEGREES	TIME	SPEED MM/SEC
0	210200	3
5	210500	3
5	210800	3
5	211100	3
5	211400	3
5	211700	3
5	212000	3
5	212300	3
5	212600	3
5	212900	3
5	213200	3
5	213500	3
5	213800	3
5	214100	3
5	214400	3
5	214700	3
5	215000	3
5	215300	3
5	215600	3
5	215900	3
5	220200	3
5	220500	3
5	220800	3
5	221100	3
5	221400	3
5	221700	3
5	222000	3
5	222300	3
5	222600	3
5	222900	3
5	223200	3
5	223500	3
5	223800	3
5	224100	3
5	224400	3
5	224700	3
5	225000	3
5	225300	3
5	225600	3
5	225900	3
5	230200	3
5	230500	3
5	230800	3
5	231100	3
5	231400	3
5	231700	3
5	232000	3
5	232300	3
5	232600	3
5	232900	3
5	233200	3
5	233500	3
5	233800	3
5	234100	3
5	234400	3
5	234700	3
5	235000	3
5	235300	3
5	235600	3
5	235900	3
5	240200	3
5	240500	3
5	240800	3
5	241100	3
5	241400	3
5	241700	3
5	242000	3
5	242300	3
5	242600	3
5	242900	3
5	243200	3
5	243500	3
5	243800	3
5	244100	3
5	244400	3
5	244700	3
5	245000	3
5	245300	3
5	245600	3
5	245900	3
5	250200	3
5	250500	3
5	250800	3
5	251100	3
5	251400	3
5	251700	3
5	252000	3
5	252300	3
5	252600	3
5	252900	3
5	253200	3
5	253500	3
5	253800	3
5	254100	3
5	254400	3
5	254700	3
5	255000	3
5	255300	3
5	255600	3
5	255900	3
5	260200	3
5	260500	3
5	260800	3
5	261100	3
5	261400	3
5	261700	3
5	262000	3
5	262300	3
5	262600	3
5	262900	3
5	263200	3
5	263500	3
5	263800	3
5	264100	3
5	264400	3
5	264700	3
5	265000	3
5	265300	3
5	265600	3
5	265900	3
5	270200	3
5	270500	3
5	270800	3
5	271100	3
5	271400	3
5	271700	3
5	272000	3
5	272300	3
5	272600	3
5	272900	3
5	273200	3
5	273500	3
5	273800	3
5	274100	3
5	274400	3
5	274700	3
5	275000	3
5	275300	3
5	275600	3
5	275900	3
5	280200	3
5	280500	3
5	280800	3
5	281100	3
5	281400	3
5	281700	3
5	282000	3
5	282300	3
5	282600	3
5	282900	3
5	283200	3
5	283500	3
5	283800	3
5	284100	3
5	284400	3
5	284700	3
5	285000	3
5	285300	3
5	285600	3
5	285900	3
5	290200	3
5	290500	3
5	290800	3
5	291100	3
5	291400	3
5	291700	3
5	292000	3
5	292300	3
5	292600	3
5	292900	3
5	293200	3
5	293500	3
5	293800	3
5	294100	3
5	294400	3
5	294700	3
5	295000	3
5	295300	3
5	295600	3
5	295900	3
5	300200	3
5	300500	3
5	300800	3
5	301100	3
5	301400	3
5	301700	3
5	302000	3
5	302300	3
5	302600	3
5	302900	3
5	303200	3
5	303500	3
5	303800	3
5	304100	3
5	304400	3
5	304700	3
5	305000	3
5	305300	3
5	305600	3
5	305900	3
5	310200	3
5	310500	3
5	310800	3
5	311100	3
5	311400	3
5	311700	3
5	312000	3
5	312300	3
5	312600	3
5	312900	3
5	313200	3
5	313500	3
5	313800	3
5	314100	3
5	314400	3
5	314700	3
5	315000	3
5	315300	3
5	315600	3
5	315900	3
5	320200	3
5	320500	3
5	320800	3
5	321100	3
5	321400	3
5	321700	3
5	322000	3
5	322300	3
5	322600	3
5	322900	3
5	323200	3
5	323500	3
5	323800	3
5	324100	3
5	324400	3
5	324700	3
5	325000	3
5	325300	3
5	325600	3
5	325900	3
5	330200	3
5	330500	3
5	330800	3
5	331100	3
5	331400	3
5	331700	3
5	332000	3
5	332300	3
5	332600	3
5	332900	3
5	333200	3
5	333500	3
5	333800	3
5	334100	3
5	334400	3
5	334700	3
5	335000	3
5	335300	3
5	335600	3
5	335900	3
5	340200	3
5	340500	3
5	340800	3
5	341100	3
5	341400	3
5	341700	3
5	342000	3
5	342300	3
5	342600	3
5	342900	3
5	343200	3
5	343500	3
5	343800	3
5	344100	3
5	344400	3
5	344700	3
5	345000	3
5	345300	3
5	345600	3
5	345900	3
5	350200	3
5	350500	3
5	350800	3
5	351100	3
5	351400	3
5	351700	3
5	352000	3
5	352300	3
5	352600	3
5	352900	3
5	353200	3
5	353500	3
5	353800	3
5	354100	3
5	354400	3
5	354700	3
5	355000	3
5	355300	3
5	355600	3
5	355900	3

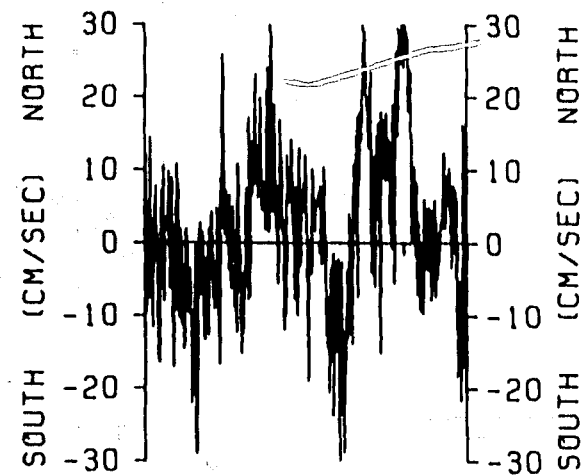

21 MAR 70

AK24
200 M

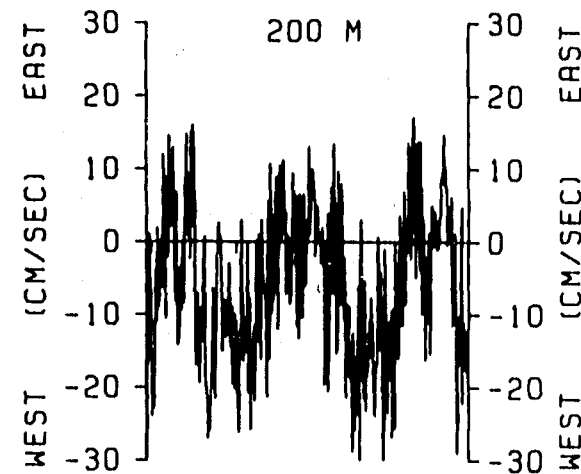

AK24
ALEXAEV

STATS

E = EAST
N = NORTH

UNITS = MM/SEC
UNITS = MM/SEC

DATE	MID TIME			MEAN		VECTOR MEAN	VARIANCE		VECTOR VARIANCE	COVARIANCE (E & N)	SPEED UNITS = MM/SEC	
	HR	MIN	SEC	(E)	(N)		(E)	(N)			MEAN	VARIANCE
70- 111-22	12	0	3	-47.	-36.	59.	3741.17	5246.93	4494.04	-853.04	109.	444.52
70- 111-23	12	0	3	-29.	-13.	32.	5590.23	5177.46	5383.84	-183.15	107.	273.91
70- 111-24	12	0	3	-48.	3.	49.	2320.81	4737.11	3524.96	284.55	96.	228.47
70- 111-25	12	0	0	-30.	7.	30.	2144.21	3595.85	2881.03	300.92	80.	320.79
70- 111-26	12	0	3	-24.	6.	25.	2451.13	3080.09	2945.61	105.26	78.	404.93
70- 111-27	12	0	3	-35.	18.	39.	3579.19	2882.51	3230.85	130.52	88.	190.27
70- 111-28	12	0	0	-43.	11.	44.	2047.02	1985.97	2034.49	-437.24	74.	236.19
70- 111-29	12	0	3	-48.	10.	49.	1572.38	1837.81	1705.10	-45.00	75.	239.49
70- 111-30	12	0	0	-40.	-10.	40.	2302.67	3248.59	2775.63	-981.72	77.	1244.39
70- 111-31	12	0	0	-24.	13.	27.	1755.89	1565.78	1643.83	137.45	62.	213.79
70- IV = 1	12	0	0	-53.	15.	55.	649.56	1946.12	1297.84	-810.36	60.	341.77

STATS

*** EAST ***
*** MM/SEC ***
MEAN = -37.00
VARIANCE = 2754.03
STD. DEV. = 52.47
KURTOSIS = 1.03
SKEWNESS = 0.00

*** NORTH ***
*** MM/SEC ***
MEAN = 0.00
VARIANCE = 3437.00
STD. DEV. = 58.63
KURTOSIS = 1.10
SKEWNESS = -0.297

*** SPEED ***
*** MM/SEC ***
MEAN = 0.00
VARIANCE = 434.17
STD. DEV. = 20.83
KURTOSIS = 1.10
SKEWNESS = 0.11

*** EAST ***
*** MM/SEC ***
COVARIANCE = 1000.00
STD. DEV. OF COVARIANCE = 3031.47
CORRELATION COEFFICIENT = 0.7053

*** EAST ***
*** MM/SEC ***
MEAN = 0.00
VARIANCE = 1000.00
STD. DEV. = 31.62

SAMPLE SIZE = 120

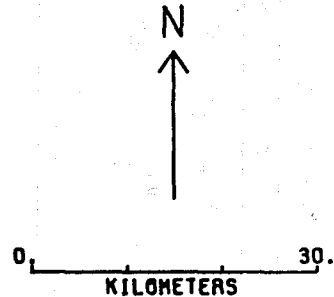

AK25
992 M

70- 111-20 TO 70- IV -02

*2 31 30 29 28 27 26 25 24 *20

KINETIC ENERGY DENSITY
CM²/SEC²
C/T.U.

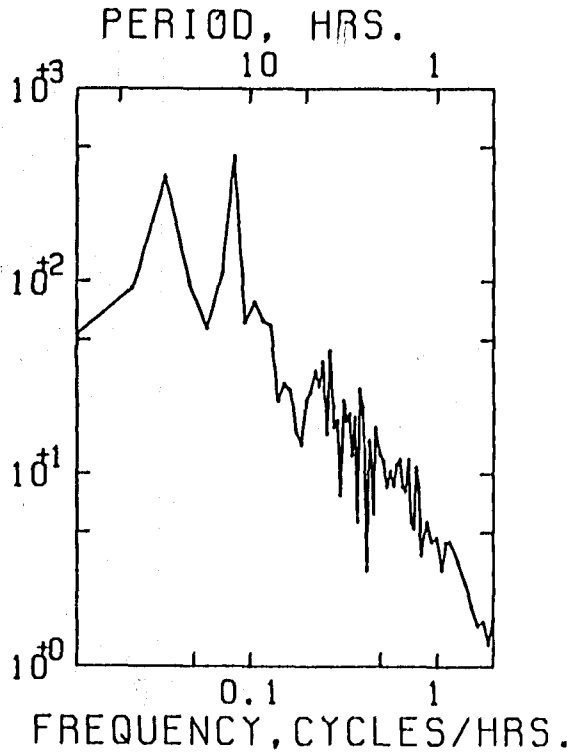

AK25
LSK

TIME	DIRECTION	SPEED
210000	000	000
210100	000	000
210200	000	000
210300	000	000
210400	000	000
210500	000	000
210600	000	000
210700	000	000
210800	000	000
210900	000	000
211000	000	000
211100	000	000
211200	000	000
211300	000	000
211400	000	000
211500	000	000
211600	000	000
211700	000	000
211800	000	000
211900	000	000
212000	000	000
212100	000	000
212200	000	000
212300	000	000
212400	000	000
212500	000	000
212600	000	000
212700	000	000
212800	000	000
212900	000	000
213000	000	000
213100	000	000
213200	000	000
213300	000	000
213400	000	000
213500	000	000
213600	000	000
213700	000	000
213800	000	000
213900	000	000
214000	000	000
214100	000	000
214200	000	000
214300	000	000
214400	000	000
214500	000	000
214600	000	000
214700	000	000
214800	000	000
214900	000	000
215000	000	000
215100	000	000
215200	000	000
215300	000	000
215400	000	000
215500	000	000
215600	000	000
215700	000	000
215800	000	000
215900	000	000
220000	000	000

DATA 0025
 SAMPLE SIZE = 1024
 SPANNING RANGE
 FROM 21 11-21 00-00-00
 TO 21 11-21 10-20-00
 AVERAGE NUMBER ELEMENTS/SAMPLE = 12
 TOTAL NUMBER OF DATA SAMPLES = 121
 NUMBER OF VALUES DATA SAMPLES = 0

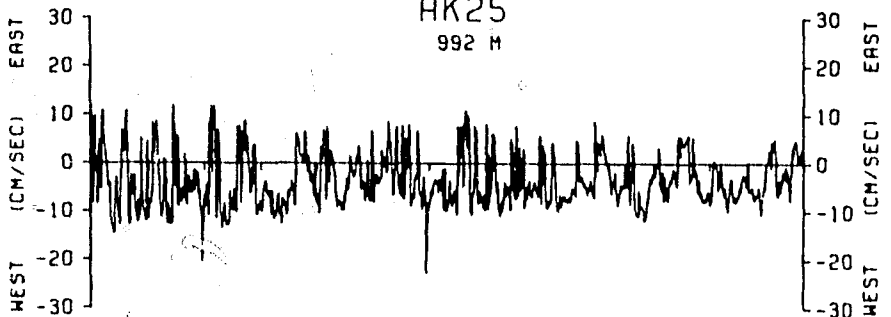
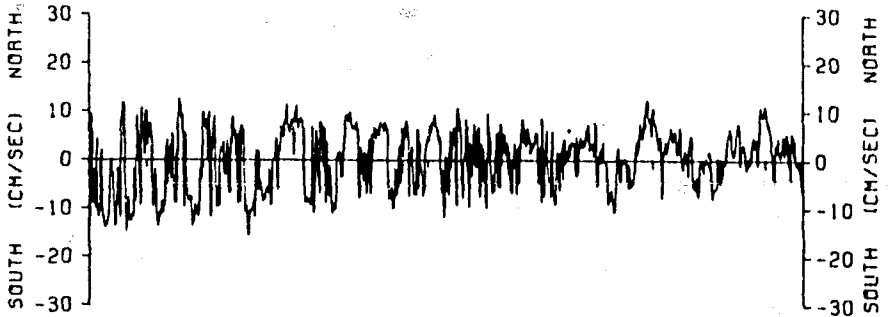

AK25
LSK

STATS

DATE	MID TIME			MEAN		MEAN	VECTOR	VARIANCE	VARIANCE	VECTOR	COVARIANCE	SPEED	
	HR	MIN	SEC	(E)	(N)	(M)	(E)	(N)	(E)	(E)	(E)	MEAN	VARIANCE
70-111-22	12	14	55	-66.	-22.	69.	10123.13	18551.29	16337.21	667.50	193.	110.53	
70-111-23	12	14	55	-60.	26.	48.	18161.30	17457.52	17803.41	1297.63	194.	107.24	
70-111-24	12	14	55	-105.	26.	108.	8135.17	11960.15	10047.66	3551.19	174.	135.82	
70-111-25	12	14	55	-58.	33.	67.	9086.32	10200.23	9643.27	2328.38	154.	75.36	
70-111-26	12	14	55	-52.	34.	62.	8041.30	11290.11	9665.70	875.81	152.	69.49	
70-111-27	12	14	55	-52.	57.	77.	10274.59	13815.36	12044.98	1701.64	173.	156.33	
70-111-28	12	14	55	-98.	53.	111.	7245.17	7455.62	7350.39	2862.72	164.	132.57	
70-111-29	12	14	55	-68.	51.	85.	4982.09	7131.43	8056.74	2004.60	139.	203.67	
70-111-30	12	14	55	-70.	8.	70.	3784.18	8994.36	8389.27	-242.65	132.	220.76	
70-111-31	12	14	55	-63.	52.	81.	9732.26	5355.09	7543.68	2889.50	146.	385.91	
70-IV-1	12	14	55	-117.	37.	123.	4970.90	11813.38	8392.14	-658.86	173.	125.67	

STAT

*** EAST ***
 *** M/SEC ***
 MEAN • 7.016 STD ERR • 3.04
 VARIANCE • 96.3091
 STD DEV • 9.8137
 KURT SIS • 0.49
 SKEW ESS • 0.015

*** NORTH ***
 *** M/SEC ***
 MEAN • 29.05 STD ERR • 3.39
 VARIANCE • 1177.71
 STD DEV • 34.318
 KURT SIS • 1.73
 SKEW ESS • -7.002

*** SPEED ***
 *** M/SEC ***
 MEAN • 10.19 STD ERR • 0.74
 VARIANCE • 56.047
 STD DEV • 7.486
 KURT SIS • 0.77
 SKEW ESS • -0.04

*** EAST ***
 *** M/SEC ***
 COVARIANCE • 1.9743 STD ERR • 302.28
 STD DEV OF COVARIANCE • 9472.42
 CORRELATION COEFFICIENT • 0.13

***** EAST & NORTH *****
 MEAN • 7.016
 VARIANCE • 170.201
 STD DEV • 13.035

SAMPLE SIZE • 30

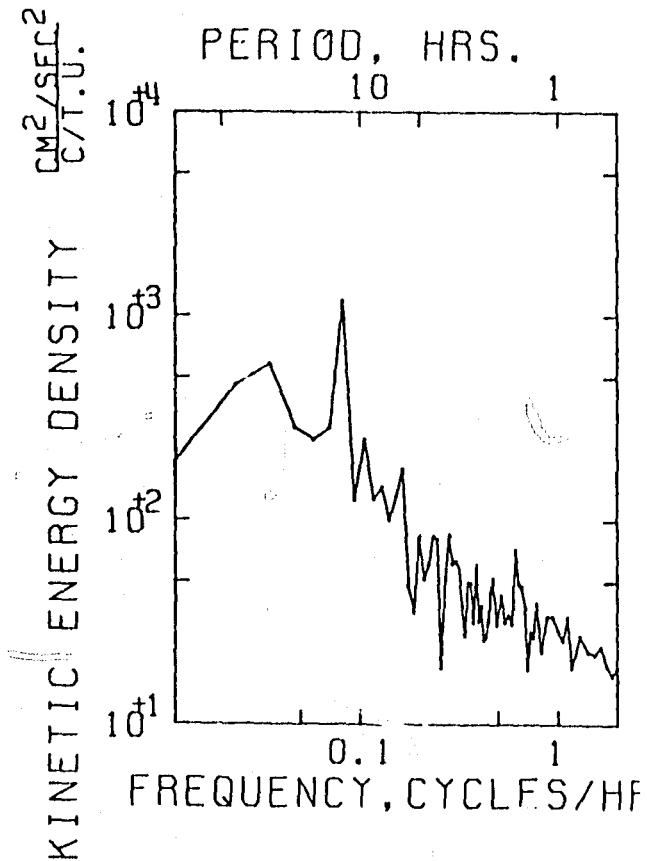
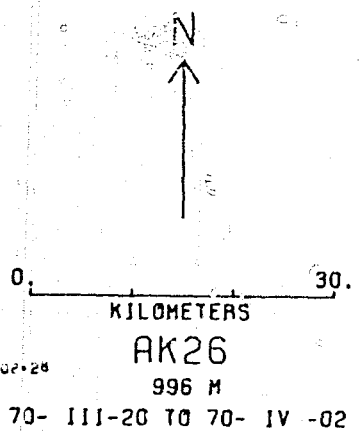

AK26
 BERGEN

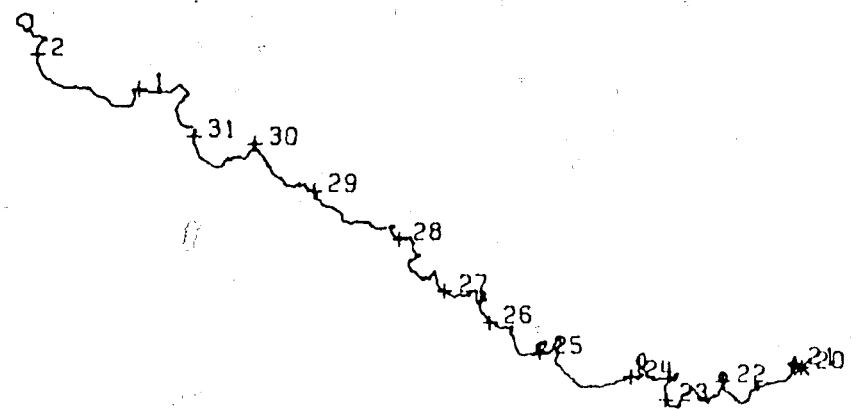

TIME PLACEMENT DATA AK26 PLOTTING BEGINS 730 117-21 03-10-85

TIME	PLACEMENT	DATA	AK26	PLOTTING BEGINS	730	117-21	03-10-85
21:00	000	000	000	000	000	000	000
21:01	000	000	000	000	000	000	000
21:02	000	000	000	000	000	000	000
21:03	000	000	000	000	000	000	000
21:04	000	000	000	000	000	000	000
21:05	000	000	000	000	000	000	000
21:06	000	000	000	000	000	000	000
21:07	000	000	000	000	000	000	000
21:08	000	000	000	000	000	000	000
21:09	000	000	000	000	000	000	000
21:10	000	000	000	000	000	000	000
21:11	000	000	000	000	000	000	000
21:12	000	000	000	000	000	000	000
21:13	000	000	000	000	000	000	000
21:14	000	000	000	000	000	000	000
21:15	000	000	000	000	000	000	000
21:16	000	000	000	000	000	000	000
21:17	000	000	000	000	000	000	000
21:18	000	000	000	000	000	000	000
21:19	000	000	000	000	000	000	000
21:20	000	000	000	000	000	000	000
21:21	000	000	000	000	000	000	000
21:22	000	000	000	000	000	000	000
21:23	000	000	000	000	000	000	000
21:24	000	000	000	000	000	000	000
21:25	000	000	000	000	000	000	000
21:26	000	000	000	000	000	000	000
21:27	000	000	000	000	000	000	000
21:28	000	000	000	000	000	000	000
21:29	000	000	000	000	000	000	000
21:30	000	000	000	000	000	000	000
21:31	000	000	000	000	000	000	000
21:32	000	000	000	000	000	000	000
21:33	000	000	000	000	000	000	000
21:34	000	000	000	000	000	000	000
21:35	000	000	000	000	000	000	000
21:36	000	000	000	000	000	000	000
21:37	000	000	000	000	000	000	000
21:38	000	000	000	000	000	000	000
21:39	000	000	000	000	000	000	000
21:40	000	000	000	000	000	000	000
21:41	000	000	000	000	000	000	000
21:42	000	000	000	000	000	000	000
21:43	000	000	000	000	000	000	000
21:44	000	000	000	000	000	000	000
21:45	000	000	000	000	000	000	000
21:46	000	000	000	000	000	000	000
21:47	000	000	000	000	000	000	000
21:48	000	000	000	000	000	000	000
21:49	000	000	000	000	000	000	000
21:50	000	000	000	000	000	000	000
21:51	000	000	000	000	000	000	000
21:52	000	000	000	000	000	000	000
21:53	000	000	000	000	000	000	000
21:54	000	000	000	000	000	000	000
21:55	000	000	000	000	000	000	000
21:56	000	000	000	000	000	000	000
21:57	000	000	000	000	000	000	000
21:58	000	000	000	000	000	000	000
21:59	000	000	000	000	000	000	000
22:00	000	000	000	000	000	000	000

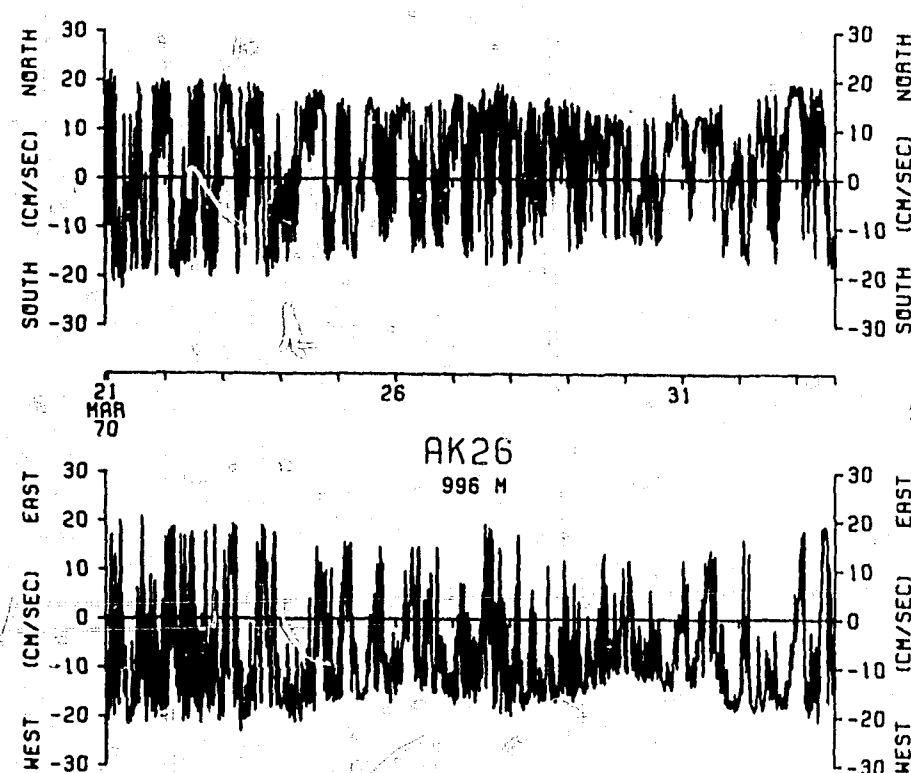

AK26
BERGEN

STATSC6

E = EAST
N = NORTH

UNITS • MM/SEC
UNITS • MM/SEC

SPEED

UNITS • MM/SEC
MEAN (E) VARIANCE (E)
MEAN (N) VARIANCE (N)
COVARIANCE (E & N)

DATE	MO	HR	MIN	SEC	MEAN (E)	MEAN (N)	VECTOR MEAN	VARIANCE (E)	VARIANCE (N)	VECTOR VARIANCE	COVARIANCE (E & N)
70- III-22	12	00	00		-36.	-16.	40.	1747.79	2698.80	2223.30	299.41
70- III-23	12	00	00		-23.	3.	29.	1853.42	1835.81	1844.62	159.34
70- III-24	12	00	00		-55.	11.	56.	2384.71	3250.19	2817.45	733.85
70- III-25	12	00	00		-43.	16.	46.	2908.97	4474.51	3691.74	524.10
70- III-26	12	00	00		-32.	16.	35.	2389.63	3282.17	2835.90	-74.52
70- III-27	12	00	00		-28.	31.	42.	2117.81	2630.88	2374.35	38.47
70- III-28	12	00	00		-48.	27.	56.	2365.21	1852.53	2105.87	149.85
70- III-29	12	00	00		-39.	36.	53.	1981.04	3313.21	2647.13	668.61
70- III-30	12	00	00		-56.	20.	59.	3291.83	7587.19	5439.51	-1119.79
70- III-31	12	00	00		-50.	32.	59.	4460.05	3427.01	3943.53	1708.04
70- IV -01	12	00	00		-67.	24.	71.	2754.76	2415.29	2585.02	-363.38

CM²/SEC²
C/T.U.

PERIOD, HRS.

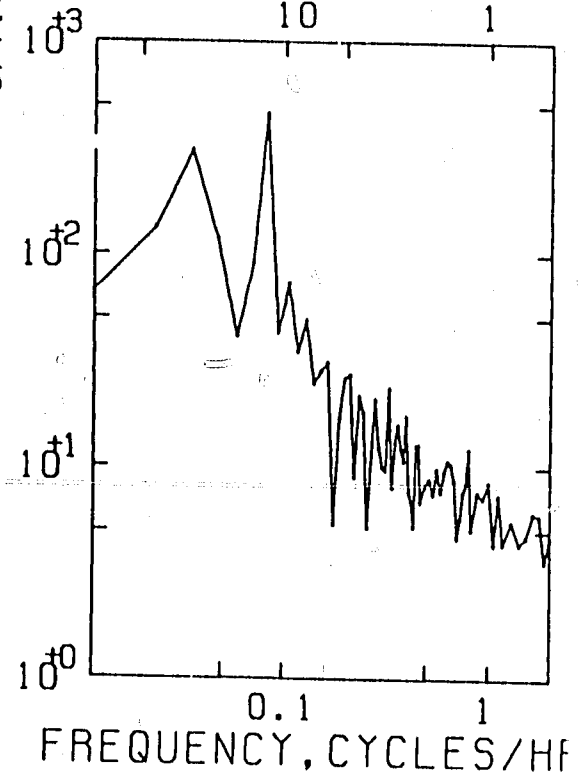

STATS

*** EAST ***
*** MM/SEC ***

MEAN • -42.66 STD ERR • 1.63
VARIANCE • 2709.73
STD. DEV. • 52.06
KURTOSIS • 2.62
SKEWNESS • -0.168

*** NORTH ***
*** MM/SEC ***

MEAN • 18.02 STD ERR • 1.87
VARIANCE • 3582.75
STD. DEV. • 59.86
KURTOSIS • 2.81
SKEWNESS • -0.074

*** SPEED ***
*** MM/SEC ***

MEAN • 82.63 STD ERR • 1.25
VARIANCE • 1609.01
STD. DEV. • 40.12
KURTOSIS • 3.19
SKEWNESS • 0.645

*** EAST & NORTH ***
*** MM/SEC ***

COVARIANCE • 223.63 STD ERR • 132.23
STD. DEV. OF COVARIANCE • 4231.29
CORRELATION COEFFICIENT • 0.072

***** VECTOR MEANS *****
***** EAST & NORTH *****

MEAN • 46.31
VARIANCE • 3146.24
STD. DEV. • 56.09

SAMPLE SIZE • 1024 POINTS



0 30
KILOMETERS

AK27

1000 M

70- III-20 TO 70- IV -02

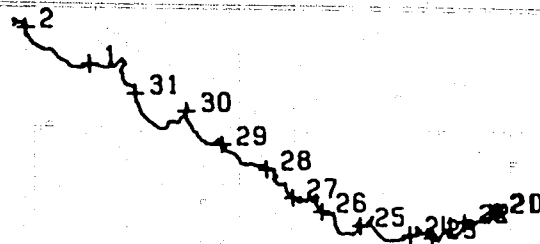

AK27
ALEXAEV

STATS

E - EAST
N - NORTH
UNITS - MM/SEC
UNITS - MM/SEC

DATE	HR	MIN	SEC	MEAN (E)	MEAN (N)	VECTOR MEAN	VARIANCE (E)	VARIANCE (N)	VECTOR VARIANCE	COVARIANCE (E & N)	MEAN (SPEED)	VARIANCE (SPEED)
70- III-22	12	0		+100.	120.	141.	13120.17	6280.17	19472.68	-254.52	220.	5407.61
70- III-23	12	0		+113.	115.	151.	8483.74	3811.14	6383.95	+227.15	140.	4631.24
70- III-24	12	0		+86.	24.	70.	11111.98	6742.15	8477.06	2011.77	150.	2143.06
70- III-25	12	0		+121.	50.	130.	9534.56	7329.50	8244.07	839.10	170.	4227.90
70- III-26	12	0		+96.	20.	39.	8039.10	7579.72	8257.43	880.93	150.	1213.16
70- III-27	12	0		+97.	34.	137.	5140.64	3861.82	5501.23	1153.35	180.	2747.67
70- III-28	12	0		+67.	84.	111.	6511.79	4155.97	5133.39	+573.92	140.	2107.00
70- III-29	12	0		+114.	-11.	110.	1704.78	5025.63	3354.20	1280.96	130.	1783.16
70- III-30	12	0		+122.	-31.	120.	5301.79	5352.37	5327.27	527.36	150.	1224.02
70- III-31	12	0		+110.	+25.	113.	3482.32	4450.14	5759.74	-1051.71	150.	1689.58
70- IV - 1	12	0		+100.	+10.	130.	2716.75	5865.87	4791.33	194.36	130.	640.99

STATG

*** EAST ***
*** MM/SEC ***
MEAN * +103.56 STD ERR * 2.65
VARIANCE * 7214.06
STD. DEV. * 84.94
KURTOSIS * 4.39
SKEWNESS * 0.888

*** NORTH ***
*** MM/SEC ***
MEAN * +5.04 STD ERR * 2.94
VARIANCE * 8834.57
STD. DEV. * 93.99
KURTOSIS * 2.77
SKEWNESS * -0.134

*** SPEED ***
*** MM/SEC ***
MEAN * 160.81 STD ERR * 1.70
VARIANCE * 2942.01
STD. DEV. * 54.24
KURTOSIS * 4.73
SKEWNESS * 1.150

*** EAST & NORTH ***
***** MM/SEC *****
COVARIANCE * 863.23 STD ERR * 22.10
STD. DEV. OF COVARIANCE * 13507.27
CORRELATION COEFFICIENT * 0.102

***** VECTOR MEANS *****
***** EAST & NORTH *****
MEAN * 112.93
VARIANCE * 8024.31
STD. DEV. * 89.58

SAMPLE SIZE * 1024 PRINTS

DATA/ 4431

DATA/ 4431

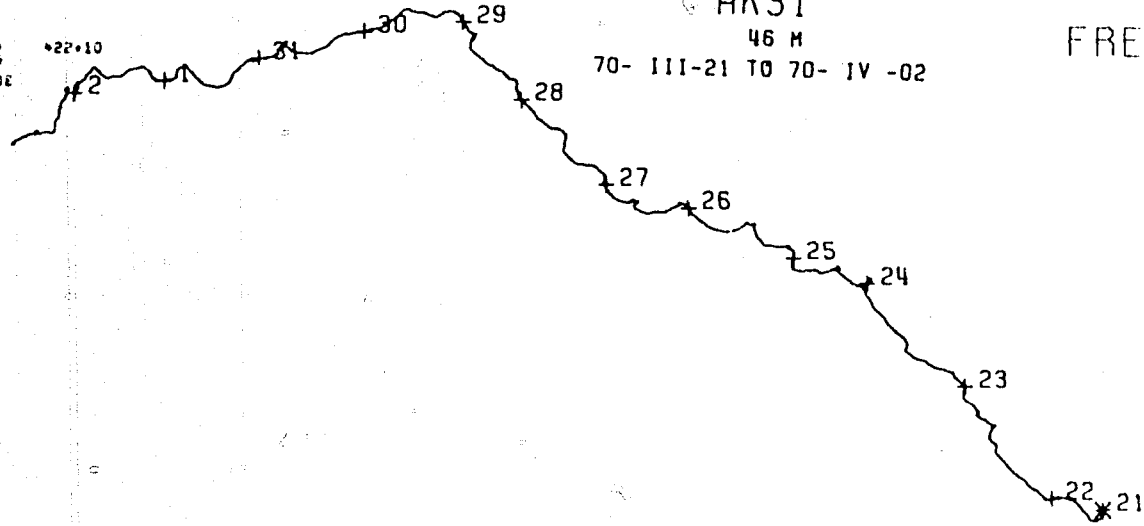

AK31
46 M
70- III-21 TO 70- IV -02

PERIOD, HOURS

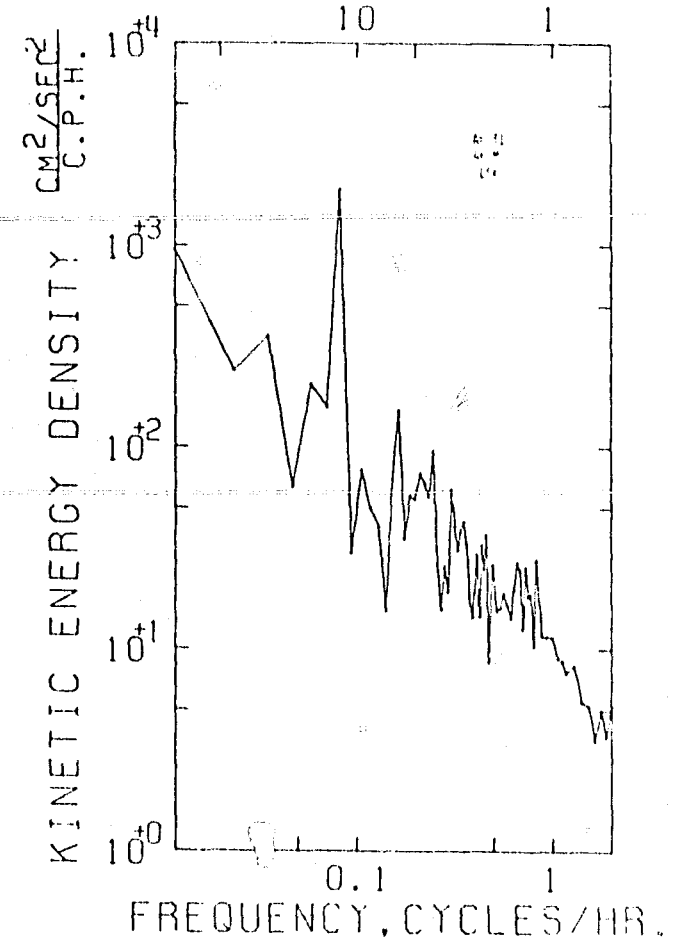

AK 31
LSK

STATS

E = EAST
N = NORTH

UNITS = MM/SEC
UNITS = MM/SEC

DATE	MO TIME			MEAN		VECTOR	VARIANCE	VARIANCE	VECTOR	COVARIANCE	SPEED	
	HR	MIN	SEC	(E)	(N)						UNITS	MM/SEC
70- III-22	12	0	0	-129.	125.	179.	12475.36	11375.20	11905.27	800.79	216.	9476.41
70- III-23	12	0	0	-162.	91.	186.	20353.49	13135.39	16700.00	2796.55	240.	8791.62
70- III-24	12	0	0	-98.	34.	100.	16661.23	11366.97	14010.10	3868.37	179.	6613.01
70- III-25	12	0	0	-133.	57.	100.	12314.21	7538.40	9927.30	2595.31	183.	7379.88
70- III-26	12	0	0	-91.	50.	105.	6014.80	9711.30	8063.05	1830.04	153.	3680.89
70- III-27	12	0	0	-33.	120.	120.	8593.19	7679.91	8036.35	795.78	167.	3701.31
70- III-28	12	0	0	-28.	91.	95.	9329.58	6566.51	7948.01	-60.18	146.	3722.22
70- III-29	12	0	0	-74.	08.	86.	7169.05	9790.83	8679.90	3140.63	142.	6455.72
70- III-30	12	0	0	-67.	8.	67.	7378.37	7863.58	7610.97	3027.27	127.	3500.75
70- III-31	12	0	0	-53.	-12.	55.	6450.72	9957.69	8206.10	-350.92	126.	3020.96
70- IV - 1	12	0	0	-38.	-16.	41.	3231.69	6920.52	5066.00	771.10	98.	1121.07

STATS

*** EAST ***
*** MM/SEC ***
MEAN = 43.81
VARIANCE = 12037.51
STD. DEV. = 109.72
KURTOSIS = 3.23
SKEWNESS = -0.297
STD ERR = 3.03

*** NORTH ***
*** MM/SEC ***
MEAN = 49.21
VARIANCE = 12094.02
STD. DEV. = 109.99
KURTOSIS = 2.70
SKEWNESS = -0.100
STD ERR = 3.04

*** SPEED ***
*** MM/SEC ***
MEAN = 163.88
VARIANCE = 6726.08
STD. DEV. = 82.01
KURTOSIS = 3.20
SKEWNESS = 0.813
STD ERR = 2.56

*** EAST & NORTH ***
UNITS = MM/SEC
COVARIANCE = 1278.98
STD. DEV. OF COVARIANCE = 16059.00
CORRELATION COEFFICIENT = 0.106
STD ERR = 501.36

***** VECTOR MEANS *****
***** EAST & NORTH *****

MEAN = 97.12
VARIANCE = 12067.77
STD. DEV. = 109.85

SAMPLE SIZE = 120 POINTS

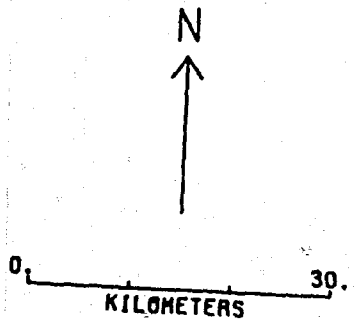

AK32
50 M
70- III-21 TO 70- IV -02

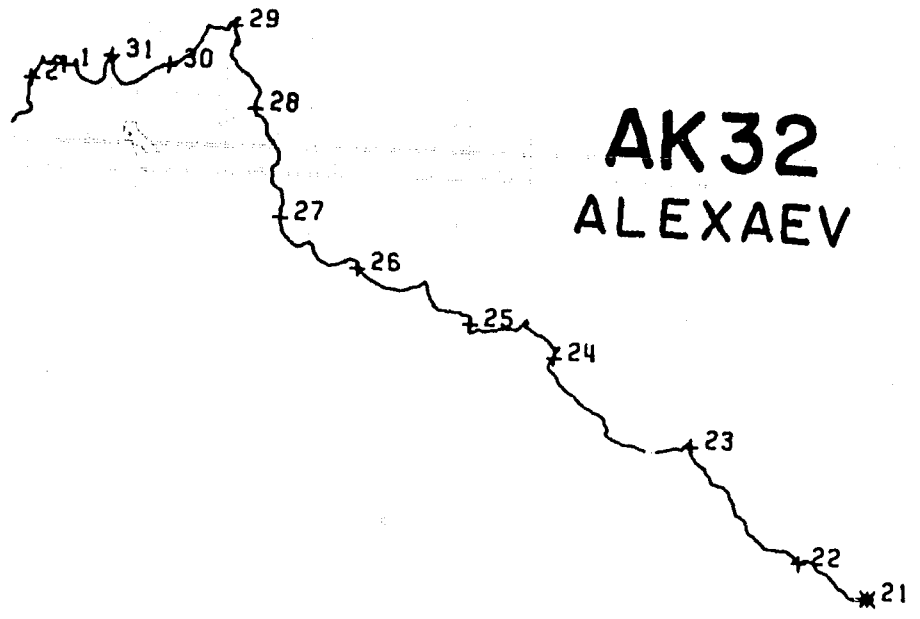
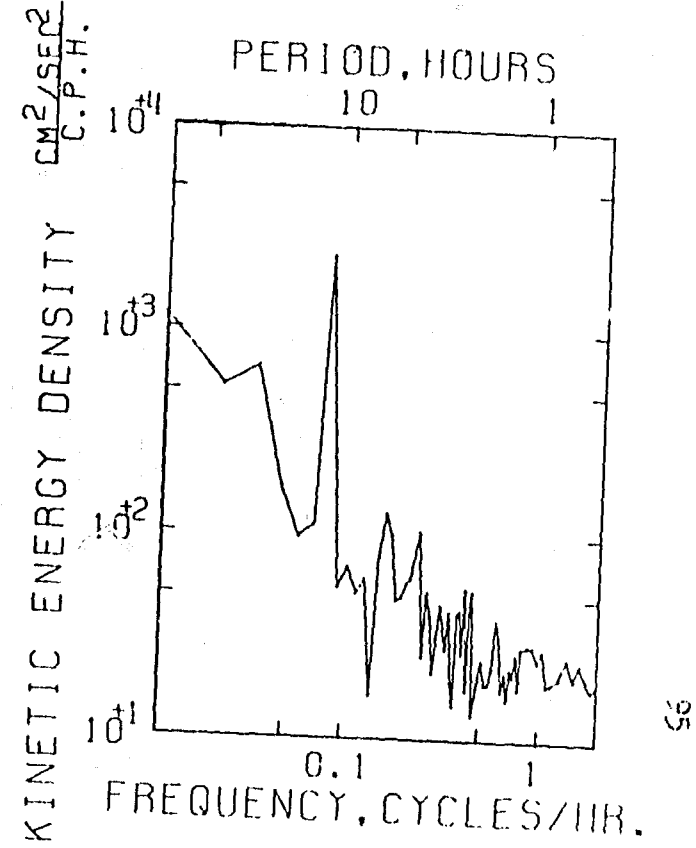

AK32
ALEXAEV

STATS
 E • EAST
 N • NORTH
 UNITS • M/SEC
 UNITS • M/SEC

DATE	HR	MIN	SEC	MEAN (E)	MEAN (N)	VECTOR MEAN	VARIANCE (E)	VARIANCE (N)	VECTOR VARIANCE	COVARIANCE (E & N)	MEAN (E)	VARIANCE (E)	MEAN (N)	VARIANCE (N)	VECTOR MEAN	COVARIANCE (E & N)	MEAN (E)	VARIANCE (E)	MEAN (N)	VARIANCE (N)	VECTOR MEAN	COVARIANCE (E & N)
70-111-22	12	0	3	10	33	30	19928.99	13866.76	16887.88	-598.07	156	10582.02	156	10582.02	156	10582.02	156	10582.02	156	10582.02	156	10582.02
70-111-23	12	0	3	113	123	123	11817.10	9195.67	10506.38	-1788.58	200	10127.04	200	10127.04	200	10127.04	200	10127.04	200	10127.04	200	10127.04
70-111-24	12	0	3	88	83	83	23589.85	14237.36	18897.11	707.83	183	8666.30	183	8666.30	183	8666.30	183	8666.30	183	8666.30	183	8666.30
70-111-25	12	0	3	10	130	130	15995.67	7731.65	11661.66	1603.84	219	7386.19	219	7386.19	219	7386.19	219	7386.19	219	7386.19	219	7386.19
70-111-26	12	0	3	87	56	56	19119.90	17066.87	18463.38	4093.14	207	9988.26	207	9988.26	207	9988.26	207	9988.26	207	9988.26	207	9988.26
70-111-27	12	0	3	84	96	96	15675.35	21126.36	18303.85	-551.31	186	12732.02	186	12732.02	186	12732.02	186	12732.02	186	12732.02	186	12732.02
70-111-28	12	0	3	112	07	07	16792.06	10828.61	13813.23	2610.82	207	8666.30	207	8666.30	207	8666.30	207	8666.30	207	8666.30	207	8666.30
70-111-29	12	0	3	86	76	76	6992.21	4437.75	5714.98	-991.91	113	4493.75	113	4493.75	113	4493.75	113	4493.75	113	4493.75	113	4493.75
70-111-30	12	0	3	91	15	15	11334.45	6453.57	8894.01	702.53	181	6676.69	181	6676.69	181	6676.69	181	6676.69	181	6676.69	181	6676.69
70-111-31	12	0	3	75	78	78	8869.71	6789.57	7829.64	-2076.37	147	5715.58	147	5715.58	147	5715.58	147	5715.58	147	5715.58	147	5715.58
70-111-IV	12	0	3	62	104	104	9855.24	7418.80	8637.02	-723.62	165	7068.73	165	7068.73	165	7068.73	165	7068.73	165	7068.73	165	7068.73

STATS

*** EAST ***
 *** M/SEC ***
 MEAN = 71.91 STD ERR = 3.94
 VARIANCE = 15872.49
 STD. DEV. = 125.98
 KURTOSIS = 2.53
 SKEWNESS = 0.006

*** NORTH ***
 *** M/SEC ***
 MEAN = 85.76 STD ERR = 3.05
 VARIANCE = 12190.54
 STD. DEV. = 110.41
 KURTOSIS = 3.10
 SKEWNESS = -0.269

*** SPEED ***
 *** M/SEC ***
 MEAN = 178.31 STD ERR = 2.97
 VARIANCE = 4797.60
 STD. DEV. = 93.76
 KURTOSIS = 2.12
 SKEWNESS = -0.002

*** LAST 5 NORTH ***
 ***** M/SEC *****

COVARIANCE = -83.73 STD ERR = 579.78 200 M
 STD. DEV. OF COVARIANCE = 18552.00
 CORRELATION COEFFICIENT = -0.035 70-111-21 TO 70-111-02

***** VECTOR MEANS *****
 ***** EAST & NORTH *****

MEAN = 111.90
 VARIANCE = 10051.52
 STD. DEV. = 110.00

SAMPLE SIZE = 172 POINTS

0 30
 KILOMETERS

AK34

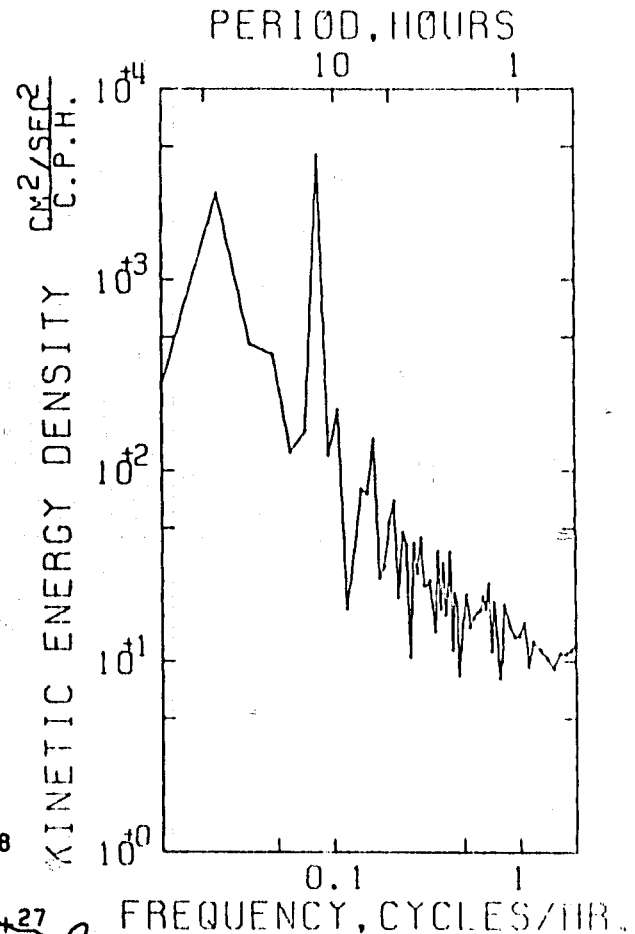
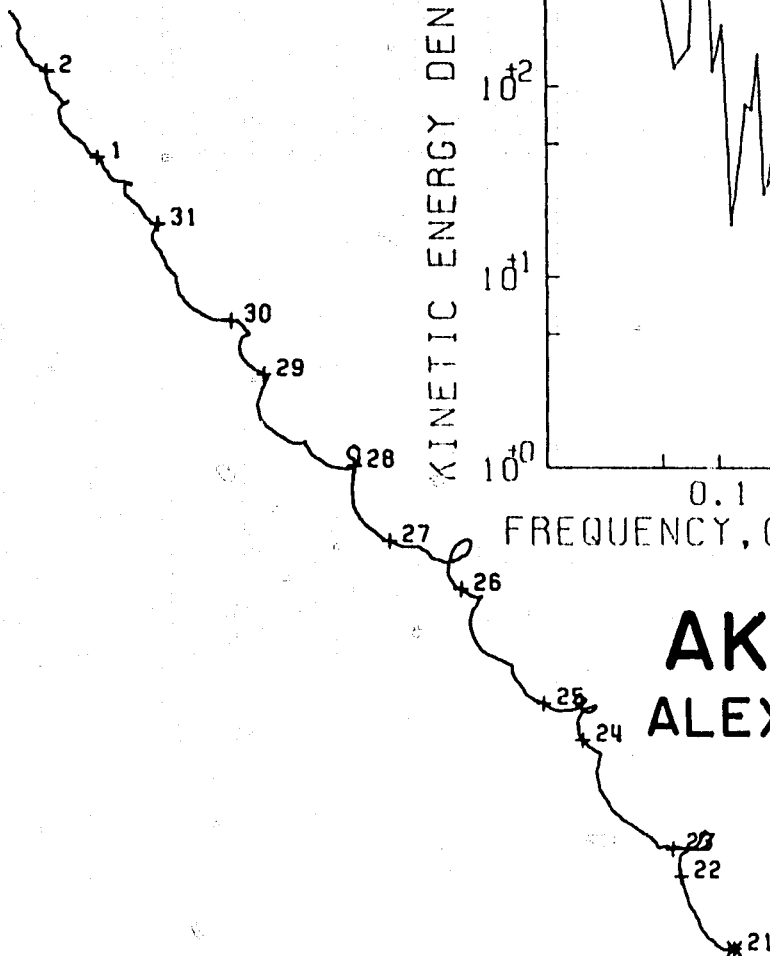

AK34
 ALEXAEV

TIME HISTORICAL DATA AK34 PLOTTING MACHINE 70-111-21 12:00:00

DIRECTION	TIME	SPEED
0	211370	230
2	211430	230
2	211500	230
2	211530	230
2	211570	230
2	211600	230
2	211630	230
2	211660	230
2	211690	230
2	211720	230
2	211750	230
2	211780	230
2	211810	230
2	211840	230
2	211870	230
2	211900	230
2	211930	230
2	211960	230
2	211990	230
2	212020	230
2	212050	230
2	212080	230
2	212110	230
2	212140	230
2	212170	230
2	212200	230
2	212230	230
2	212260	230
2	212290	230
2	212320	230
2	212350	230
2	212380	230
2	212410	230
2	212440	230
2	212470	230
2	212500	230
2	212530	230
2	212560	230
2	212590	230
2	212620	230
2	212650	230
2	212680	230
2	212710	230
2	212740	230
2	212770	230
2	212800	230
2	212830	230
2	212860	230
2	212890	230
2	212920	230
2	212950	230
2	212980	230
2	213010	230
2	213040	230
2	213070	230
2	213100	230
2	213130	230
2	213160	230
2	213190	230
2	213220	230
2	213250	230
2	213280	230
2	213310	230
2	213340	230
2	213370	230
2	213400	230
2	213430	230
2	213460	230
2	213490	230
2	213520	230
2	213550	230
2	213580	230
2	213610	230
2	213640	230
2	213670	230
2	213700	230
2	213730	230
2	213760	230
2	213790	230
2	213820	230
2	213850	230
2	213880	230
2	213910	230
2	213940	230
2	213970	230
2	214000	230
2	214030	230
2	214060	230
2	214090	230
2	214120	230
2	214150	230
2	214180	230
2	214210	230
2	214240	230
2	214270	230
2	214300	230
2	214330	230
2	214360	230
2	214390	230
2	214420	230
2	214450	230
2	214480	230
2	214510	230
2	214540	230
2	214570	230
2	214600	230
2	214630	230
2	214660	230
2	214690	230
2	214720	230
2	214750	230
2	214780	230
2	214810	230
2	214840	230
2	214870	230
2	214900	230
2	214930	230
2	214960	230
2	214990	230
2	215020	230
2	215050	230
2	215080	230
2	215110	230
2	215140	230
2	215170	230
2	215200	230
2	215230	230
2	215260	230
2	215290	230
2	215320	230
2	215350	230
2	215380	230
2	215410	230
2	215440	230
2	215470	230
2	215500	230
2	215530	230
2	215560	230
2	215590	230
2	215620	230
2	215650	230
2	215680	230
2	215710	230
2	215740	230
2	215770	230
2	215800	230
2	215830	230
2	215860	230
2	215890	230
2	215920	230
2	215950	230
2	215980	230
2	216010	230
2	216040	230
2	216070	230
2	216100	230
2	216130	230
2	216160	230
2	216190	230
2	216220	230
2	216250	230
2	216280	230
2	216310	230
2	216340	230
2	216370	230
2	216400	230
2	216430	230
2	216460	230
2	216490	230
2	216520	230
2	216550	230
2	216580	230
2	216610	230
2	216640	230
2	216670	230
2	216700	230
2	216730	230
2	216760	230
2	216790	230
2	216820	230
2	216850	230
2	216880	230
2	216910	230
2	216940	230
2	216970	230
2	217000	230
2	217030	230
2	217060	230
2	217090	230
2	217120	230
2	217150	230
2	217180	230
2	217210	230
2	217240	230
2	217270	230
2	217300	230
2	217330	230
2	217360	230
2	217390	230
2	217420	230
2	217450	230
2	217480	230
2	217510	230
2	217540	230
2	217570	230
2	217600	230
2	217630	230
2	217660	230
2	217690	230
2	217720	230
2	217750	230
2	217780	230
2	217810	230
2	217840	230
2	217870	230
2	217900	230
2	217930	230
2	217960	230
2	217990	230
2	218020	230
2	218050	230
2	218080	230
2	218110	230
2	218140	230
2	218170	230
2	218200	230
2	218230	230
2	218260	230
2	218290	230
2	218320	230
2	218350	230
2	218380	230
2	218410	230
2	218440	230
2	218470	230
2	218500	230
2	218530	230
2	218560	230
2	218590	230
2	218620	230
2	218650	230
2	218680	230
2	218710	230
2	218740	230
2	218770	230
2	218800	230
2	218830	230
2	218860	230
2	218890	230
2	218920	230
2	218950	230
2	218980	230
2	219010	230
2	219040	230
2	219070	230
2	219100	230
2	219130	230
2	219160	230
2	219190	230
2	219220	230
2	219250	230
2	219280	230
2	219310	230
2	219340	230
2	219370	230
2	219400	230
2	219430	230
2	219460	230
2	219490	230
2	219520	230
2	219550	230
2	219580	230
2	219610	230
2	219640	230
2	219670	230
2	219700	230
2	219730	230
2	219760	230
2	219790	230
2	219820	230
2	219850	230
2	219880	230
2	219910	230
2	219940	230
2	219970	230
2	220000	230

DATA AK34
 SAMPLE RATE = 10000.000 SEC/CS
 SPAN/RS RANGE
 FROM 70-111-21 12:00:00
 TO 70-11-02 14:15:00
 AVERAGE NUMBER ELEMENTS/SAMPLE = 12
 TOTAL NUMBER OF DATA SAMPLES = 56
 NUMBER OF VALID DATA SAMPLES = 56
 NUMBER OF NON-STANDARD RECORDS = 0
 DATE 1972 OCT 27 17:170

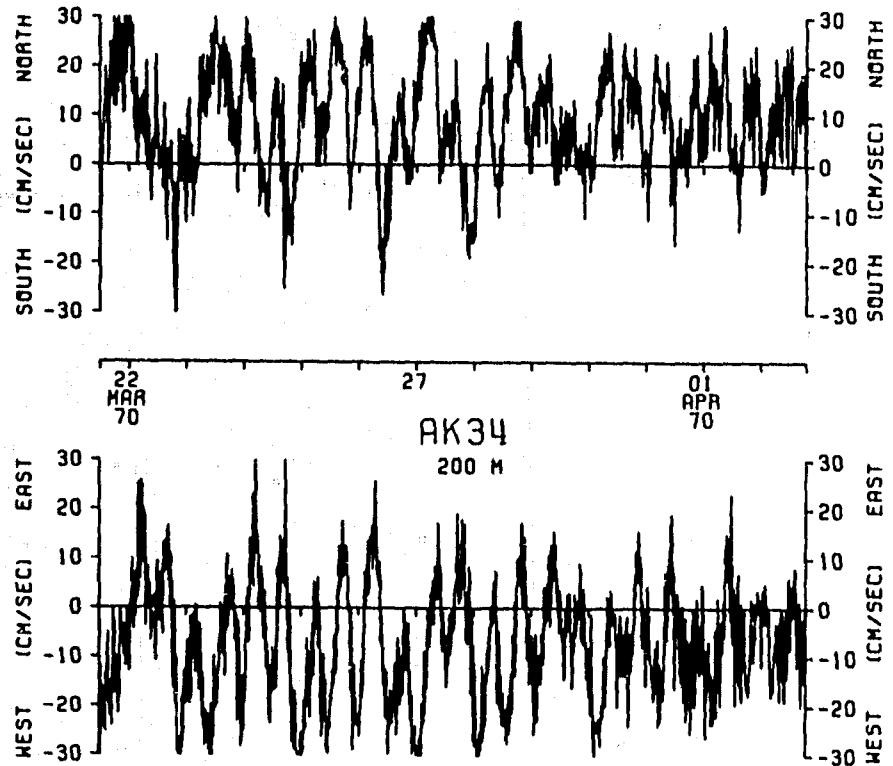

AK34
 ALEXAEV

STATS

E = EAST
N = NORTH

UNITS = MM/SEC
UNITS = MM/SEC

DATE	MID TIME			MEAN		VECTOR	VARIANCE	VARIANCE	VECTOR	COVARIANCE	SPEED	
	HR	MIN	SEC	(E)	(N)	MEAN	(E)	(N)	VARIANCE	(E & N)	MEAN	VARIANCE
70- 111-22	12	12	30	120	620	630	17254017	14097024	15676070	2813092	1870	278057
70- 111-23	12	12	30	-930	1220	1930	4694000	3011090	3852095	1813018	1750	495033
70- 111-24	12	12	30	-240	300	340	1417012	10492031	12031021	2125046	1610	455017
70- 111-25	12	12	30	-860	980	1170	6282037	4573005	5427071	1791088	1560	368065
70- 111-26	12	12	30	-690	260	780	9493047	8767070	9130058	1049095	1550	607057
70- 111-27	12	12	30	-360	690	780	9589003	12672087	11130095	-1121066	1670	512086
70- 111-28	12	12	30	-750	880	1110	8087032	6733078	7010054	1393055	1600	508042
70- 111-29	12	12	30	-960	690	880	4942076	4224070	4583073	570071	1290	205050
70- 111-30	12	12	30	-610	890	1080	5368044	4162097	4765070	1078073	1430	560442
70- 111-31	12	12	30	-670	760	1320	4440003	4802037	4471020	628021	1380	244019
70- 111-1	12	12	30	-930	820	920	8752077	5801057	7277017	-1086036	1510	180060

STATS

MEAN = 57000 ST. ERR = 300
 VARIANCE = 537000
 STD. DEV. = 730
 KURTOSIS = 200
 SKEWNESS = 060

MEAN = 73020 ST. ERR = 2079
 VARIANCE = 796000
 STD. DEV. = 890
 KURTOSIS = 3012
 SKEWNESS = 0098

MEAN = 157000 ST. ERR = 3060
 VARIANCE = 600000
 STD. DEV. = 2400
 KURTOSIS = 2083
 SKEWNESS = 0093

COVARIANCE = 900000 STD. ERR = 24000
 STD. DEV. OF COVARIANCE = 917000
 CORR. LATITUDE COEFFICIENT = 0070

MEAN = 900
 VARIANCE = 307000
 STD. DEV. = 550

SAMPLE SIZE = 120 PRINTS



0 30
KILOMETERS

AK35

204 M

70- 111-21 TO 70- 111-31

PERIOD, HOURS

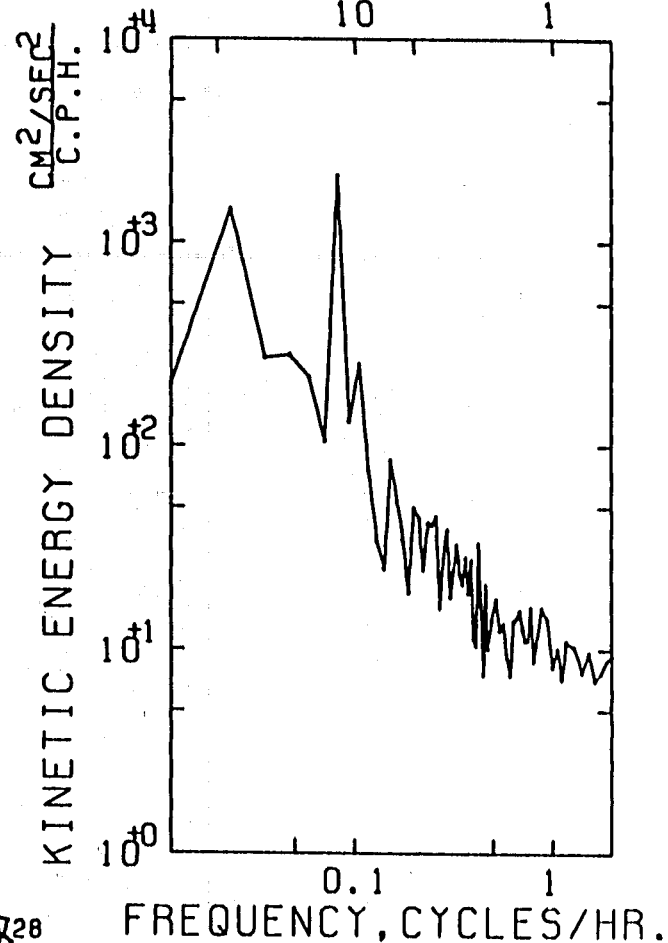

AK35
BERGEN

TIME HISTOGRAM DATA 0435 P.07714 BERGEN 70-111-01 12-12-70

TIME	DISPLACEMENT	SPEED
00	000000	000000
01	000000	000000
02	000000	000000
03	000000	000000
04	000000	000000
05	000000	000000
06	000000	000000
07	000000	000000
08	000000	000000
09	000000	000000
10	000000	000000
11	000000	000000
12	000000	000000
13	000000	000000
14	000000	000000
15	000000	000000
16	000000	000000
17	000000	000000
18	000000	000000
19	000000	000000
20	000000	000000
21	000000	000000
22	000000	000000
23	000000	000000
24	000000	000000
25	000000	000000
26	000000	000000
27	000000	000000
28	000000	000000
29	000000	000000
30	000000	000000
31	000000	000000
32	000000	000000
33	000000	000000
34	000000	000000
35	000000	000000
36	000000	000000
37	000000	000000
38	000000	000000
39	000000	000000
40	000000	000000
41	000000	000000
42	000000	000000
43	000000	000000
44	000000	000000
45	000000	000000
46	000000	000000
47	000000	000000
48	000000	000000
49	000000	000000
50	000000	000000
51	000000	000000
52	000000	000000
53	000000	000000
54	000000	000000
55	000000	000000
56	000000	000000
57	000000	000000
58	000000	000000
59	000000	000000
60	000000	000000
61	000000	000000
62	000000	000000
63	000000	000000
64	000000	000000
65	000000	000000
66	000000	000000
67	000000	000000
68	000000	000000
69	000000	000000
70	000000	000000
71	000000	000000
72	000000	000000
73	000000	000000
74	000000	000000
75	000000	000000
76	000000	000000
77	000000	000000
78	000000	000000
79	000000	000000
80	000000	000000
81	000000	000000
82	000000	000000
83	000000	000000
84	000000	000000
85	000000	000000
86	000000	000000
87	000000	000000
88	000000	000000
89	000000	000000
90	000000	000000
91	000000	000000
92	000000	000000
93	000000	000000
94	000000	000000
95	000000	000000
96	000000	000000
97	000000	000000
98	000000	000000
99	000000	000000
100	000000	000000

DATA 0435
 SAMPLE SIZE = 1-SEC
 SPAN = 1-SEC
 AVERAGE = 12
 TOTAL NUMBER OF DATA SAMPLES = 100
 NUMBER OF ANALYSIS DATA SAMPLES = 100
 NUMBER OF NON-ANALYSIS RECORDS = 0
 JOB END DATE 04/01/70

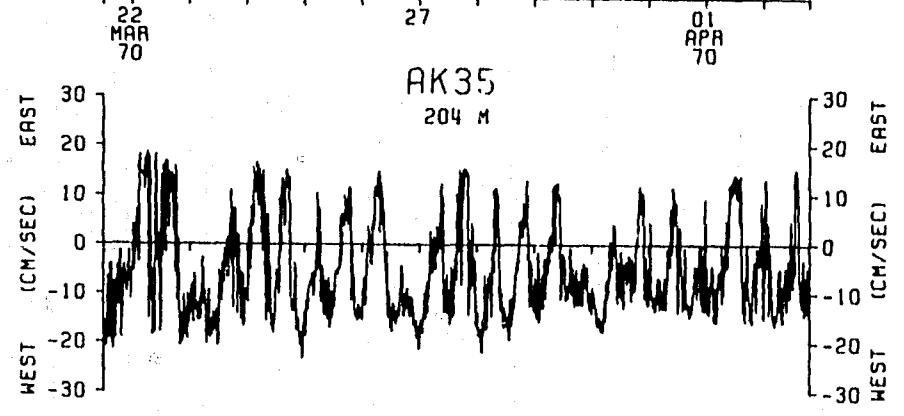
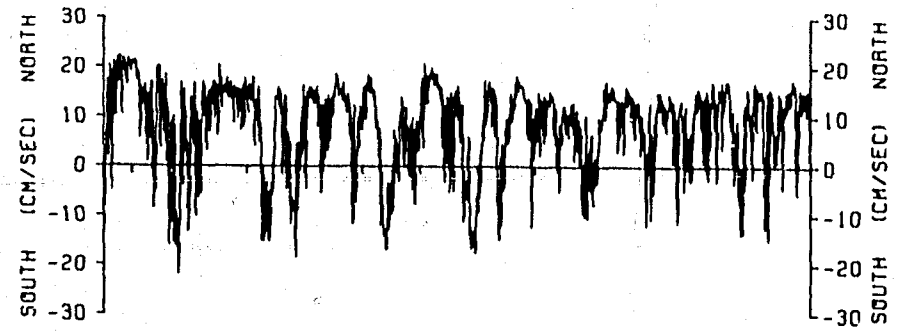

AK35
 BERGEN

STAT506

E • EAST UNITS • MM/SEC
 N • NORTH UNITS • MM/SEC

DATE	TIME	MEAN (E)	MEAN (N)	VECTOR MEAN	VARIANCE (E)	VARIANCE (N)	VECTOR VARIANCE	COVARIANCE (E N)
70- III-22	12-11-16	5.	27.	27.	2620.56	4492.06	3556.31	214.37
70- III-23	12-11-16	-5.	44.	48.	2620.67	3122.54	2592.60	229.99
70- III-24	12-11-16	-19.	48.	52.	1754.48	2023.27	1888.88	164.83
70- III-25	12-11-16	-14.	37.	39.	2431.81	1801.44	2116.62	211.79
70- III-26	12-11-16	-12.	45.	46.	1984.77	2293.96	2139.36	354.06
70- III-27	12-11-16	-14.	55.	56.	1739.27	1927.01	1833.14	-116.89
70- III-28	12-11-16	-22.	36.	43.	2478.56	1236.25	1857.41	103.03
70- III-29	12-11-16	-14.	59.	61.	2298.96	2036.41	2167.69	-244.96
70- III-30	12-11-16	-31.	27.	41.	1307.54	1826.44	1566.99	535.10
70- III-31	12-11-16	-16.	44.	47.	1442.51	2024.24	1733.38	400.51
70- IV -01	12-11-16	-72.	27.	76.	606.85	2499.49	1553.17	388.72

SPEED

UNITS • MM/SEC

MEAN (E)	VARIANCE (E)
77.	660.14
86.	921.42
80.	709.46
72.	478.59
77.	807.49
70.	610.37
75.	946.13
82.	778.37
69.	940.91
66.	509.50
84.	546.03

STAT506

••• EAST •••
 ••• MM/SEC •••

MEAN • 17.98 STD ERR • 1.06
 VARIANCE • 2195.79
 STD. DEV. • 46.86
 KURTOSIS • 2.50
 SKEWNESS • .094

••• NORTH •••
 ••• MM/SEC •••

MEAN • 41.59 STD ERR • 1.53
 VARIANCE • 2406.58
 STD. DEV. • 49.06
 KURTOSIS • 3.83
 SKEWNESS • .938

••• SPEED •••
 ••• MM/SEC •••

MEAN • 76.71 STD ERR • .87
 VARIANCE • 770.78
 STD. DEV. • 27.76
 KURTOSIS • 2.63
 SKEWNESS • .068

••• EAST & NORTH •••
 ••• MM/SEC •••

COVARIANCE • 181.63 STD ERR • 87.67
 STD. DEV. OF COVARIANCE • 2803.56
 CORRELATION COEFFICIENT • .079

••• VECTOR MEANS •••
 ••• EAST & NORTH •••

MEAN • 45.31
 VARIANCE • 2301.19
 STD. DEV. • 47.97

SAMPLE SIZE • 1024 POINTS

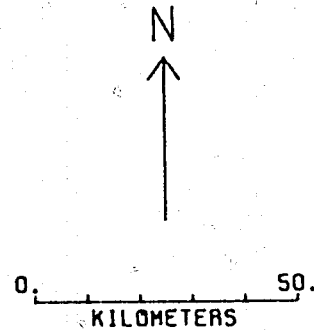

AK37A
 1003 M
 70- III-21 TO 70- IV -02

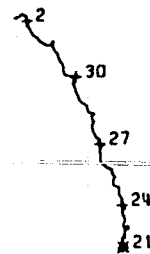

KINETIC ENERGY DENSITY CM²/SEC² C/T.U.²

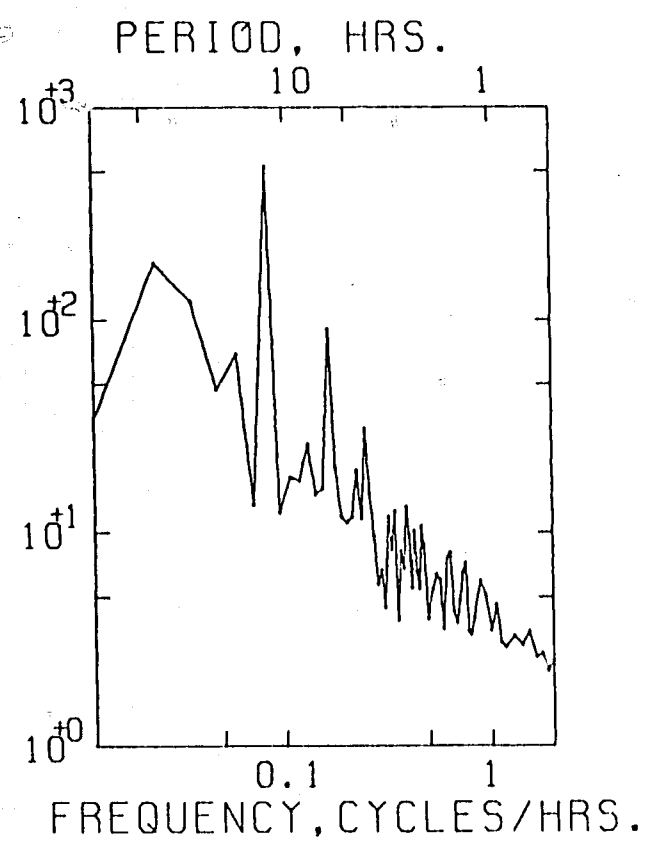

PERIOD, HRS.
 10 1

AK37A
 GEODYNE

TIME ESTIMATE DATA AK37A PLOTTING BEGINS 70-111-21 11:00:16

TIME	DIRECTION	SPEED	TIME	DIRECTION	SPEED
05 51 1	05 51 1	5 5	211210	0 55 45555	5 5 5
05 51 2	05 51 2	5 5	211310	5 55 55555	5 5 5
05 51 3	05 51 3	5 5	211410	2 1222 2 2 5	5
05 51 4	05 51 4	5 5	211510	3 37 30 30 3 3	3
05 51 5	05 51 5	5 5	211610	3 3 0 3333 3	3
05 51 6	05 51 6	5 5	211710	55 5 30 3 3033	5
05 51 7	05 51 7	5 5	211810	55 5 3 555 5	5
05 51 8	05 51 8	5 5	211910	55 5 3 33 3 6	5
05 51 9	05 51 9	5 5	212010	5 55 5 55 555	5
05 51 10	05 51 10	5 5	212110	5 55 5 5 555 5	5
05 51 11	05 51 11	5 5	212210	3 3 33 3 0 3 4 2 3	3
05 51 12	05 51 12	5 5	212310	0 0 0 0 0 0 0 0 0	0
05 51 13	05 51 13	5 5	212410	5 5 5 5 5 5 5 5 5	5
05 51 14	05 51 14	5 5	212510	5 5 5 5 5 5 5 5 5	5
05 51 15	05 51 15	5 5	212610	5 5 5 5 5 5 5 5 5	5
05 51 16	05 51 16	5 5	212710	5 5 5 5 5 5 5 5 5	5
05 51 17	05 51 17	5 5	212810	5 5 5 5 5 5 5 5 5	5
05 51 18	05 51 18	5 5	212910	5 5 5 5 5 5 5 5 5	5
05 51 19	05 51 19	5 5	213010	5 5 5 5 5 5 5 5 5	5
05 51 20	05 51 20	5 5	213110	5 5 5 5 5 5 5 5 5	5
05 51 21	05 51 21	5 5	213210	5 5 5 5 5 5 5 5 5	5
05 51 22	05 51 22	5 5	213310	5 5 5 5 5 5 5 5 5	5
05 51 23	05 51 23	5 5	213410	5 5 5 5 5 5 5 5 5	5
05 51 24	05 51 24	5 5	213510	5 5 5 5 5 5 5 5 5	5
05 51 25	05 51 25	5 5	213610	5 5 5 5 5 5 5 5 5	5
05 51 26	05 51 26	5 5	213710	5 5 5 5 5 5 5 5 5	5
05 51 27	05 51 27	5 5	213810	5 5 5 5 5 5 5 5 5	5
05 51 28	05 51 28	5 5	213910	5 5 5 5 5 5 5 5 5	5
05 51 29	05 51 29	5 5	214010	5 5 5 5 5 5 5 5 5	5
05 51 30	05 51 30	5 5	214110	5 5 5 5 5 5 5 5 5	5
05 51 31	05 51 31	5 5	214210	5 5 5 5 5 5 5 5 5	5
05 51 32	05 51 32	5 5	214310	5 5 5 5 5 5 5 5 5	5
05 51 33	05 51 33	5 5	214410	5 5 5 5 5 5 5 5 5	5
05 51 34	05 51 34	5 5	214510	5 5 5 5 5 5 5 5 5	5
05 51 35	05 51 35	5 5	214610	5 5 5 5 5 5 5 5 5	5
05 51 36	05 51 36	5 5	214710	5 5 5 5 5 5 5 5 5	5
05 51 37	05 51 37	5 5	214810	5 5 5 5 5 5 5 5 5	5
05 51 38	05 51 38	5 5	214910	5 5 5 5 5 5 5 5 5	5
05 51 39	05 51 39	5 5	215010	5 5 5 5 5 5 5 5 5	5
05 51 40	05 51 40	5 5	215110	5 5 5 5 5 5 5 5 5	5
05 51 41	05 51 41	5 5	215210	5 5 5 5 5 5 5 5 5	5
05 51 42	05 51 42	5 5	215310	5 5 5 5 5 5 5 5 5	5
05 51 43	05 51 43	5 5	215410	5 5 5 5 5 5 5 5 5	5
05 51 44	05 51 44	5 5	215510	5 5 5 5 5 5 5 5 5	5
05 51 45	05 51 45	5 5	215610	5 5 5 5 5 5 5 5 5	5
05 51 46	05 51 46	5 5	215710	5 5 5 5 5 5 5 5 5	5
05 51 47	05 51 47	5 5	215810	5 5 5 5 5 5 5 5 5	5
05 51 48	05 51 48	5 5	215910	5 5 5 5 5 5 5 5 5	5
05 51 49	05 51 49	5 5	216010	5 5 5 5 5 5 5 5 5	5
05 51 50	05 51 50	5 5	216110	5 5 5 5 5 5 5 5 5	5
05 51 51	05 51 51	5 5	216210	5 5 5 5 5 5 5 5 5	5
05 51 52	05 51 52	5 5	216310	5 5 5 5 5 5 5 5 5	5
05 51 53	05 51 53	5 5	216410	5 5 5 5 5 5 5 5 5	5
05 51 54	05 51 54	5 5	216510	5 5 5 5 5 5 5 5 5	5
05 51 55	05 51 55	5 5	216610	5 5 5 5 5 5 5 5 5	5
05 51 56	05 51 56	5 5	216710	5 5 5 5 5 5 5 5 5	5
05 51 57	05 51 57	5 5	216810	5 5 5 5 5 5 5 5 5	5
05 51 58	05 51 58	5 5	216910	5 5 5 5 5 5 5 5 5	5
05 51 59	05 51 59	5 5	217010	5 5 5 5 5 5 5 5 5	5
05 51 60	05 51 60	5 5	217110	5 5 5 5 5 5 5 5 5	5
05 51 61	05 51 61	5 5	217210	5 5 5 5 5 5 5 5 5	5
05 51 62	05 51 62	5 5	217310	5 5 5 5 5 5 5 5 5	5
05 51 63	05 51 63	5 5	217410	5 5 5 5 5 5 5 5 5	5
05 51 64	05 51 64	5 5	217510	5 5 5 5 5 5 5 5 5	5
05 51 65	05 51 65	5 5	217610	5 5 5 5 5 5 5 5 5	5
05 51 66	05 51 66	5 5	217710	5 5 5 5 5 5 5 5 5	5
05 51 67	05 51 67	5 5	217810	5 5 5 5 5 5 5 5 5	5
05 51 68	05 51 68	5 5	217910	5 5 5 5 5 5 5 5 5	5
05 51 69	05 51 69	5 5	218010	5 5 5 5 5 5 5 5 5	5
05 51 70	05 51 70	5 5	218110	5 5 5 5 5 5 5 5 5	5
05 51 71	05 51 71	5 5	218210	5 5 5 5 5 5 5 5 5	5
05 51 72	05 51 72	5 5	218310	5 5 5 5 5 5 5 5 5	5
05 51 73	05 51 73	5 5	218410	5 5 5 5 5 5 5 5 5	5
05 51 74	05 51 74	5 5	218510	5 5 5 5 5 5 5 5 5	5
05 51 75	05 51 75	5 5	218610	5 5 5 5 5 5 5 5 5	5
05 51 76	05 51 76	5 5	218710	5 5 5 5 5 5 5 5 5	5
05 51 77	05 51 77	5 5	218810	5 5 5 5 5 5 5 5 5	5
05 51 78	05 51 78	5 5	218910	5 5 5 5 5 5 5 5 5	5
05 51 79	05 51 79	5 5	219010	5 5 5 5 5 5 5 5 5	5
05 51 80	05 51 80	5 5	219110	5 5 5 5 5 5 5 5 5	5
05 51 81	05 51 81	5 5	219210	5 5 5 5 5 5 5 5 5	5
05 51 82	05 51 82	5 5	219310	5 5 5 5 5 5 5 5 5	5
05 51 83	05 51 83	5 5	219410	5 5 5 5 5 5 5 5 5	5
05 51 84	05 51 84	5 5	219510	5 5 5 5 5 5 5 5 5	5
05 51 85	05 51 85	5 5	219610	5 5 5 5 5 5 5 5 5	5
05 51 86	05 51 86	5 5	219710	5 5 5 5 5 5 5 5 5	5
05 51 87	05 51 87	5 5	219810	5 5 5 5 5 5 5 5 5	5
05 51 88	05 51 88	5 5	219910	5 5 5 5 5 5 5 5 5	5
05 51 89	05 51 89	5 5	220010	5 5 5 5 5 5 5 5 5	5
05 51 90	05 51 90	5 5	220110	5 5 5 5 5 5 5 5 5	5
05 51 91	05 51 91	5 5	220210	5 5 5 5 5 5 5 5 5	5
05 51 92	05 51 92	5 5	220310	5 5 5 5 5 5 5 5 5	5
05 51 93	05 51 93	5 5	220410	5 5 5 5 5 5 5 5 5	5
05 51 94	05 51 94	5 5	220510	5 5 5 5 5 5 5 5 5	5
05 51 95	05 51 95	5 5	220610	5 5 5 5 5 5 5 5 5	5
05 51 96	05 51 96	5 5	220710	5 5 5 5 5 5 5 5 5	5
05 51 97	05 51 97	5 5	220810	5 5 5 5 5 5 5 5 5	5
05 51 98	05 51 98	5 5	220910	5 5 5 5 5 5 5 5 5	5
05 51 99	05 51 99	5 5	221010	5 5 5 5 5 5 5 5 5	5
05 51 100	05 51 100	5 5	221110	5 5 5 5 5 5 5 5 5	5

DATA AK37A
 SAMPLE SIZE = 100
 SPAN = 100
 TOTAL NUMBER OF DATA SAMPLES = 100
 NUMBER OF DATA SAMPLES USED = 100
 NUMBER OF DATA SAMPLES REJECTED = 0

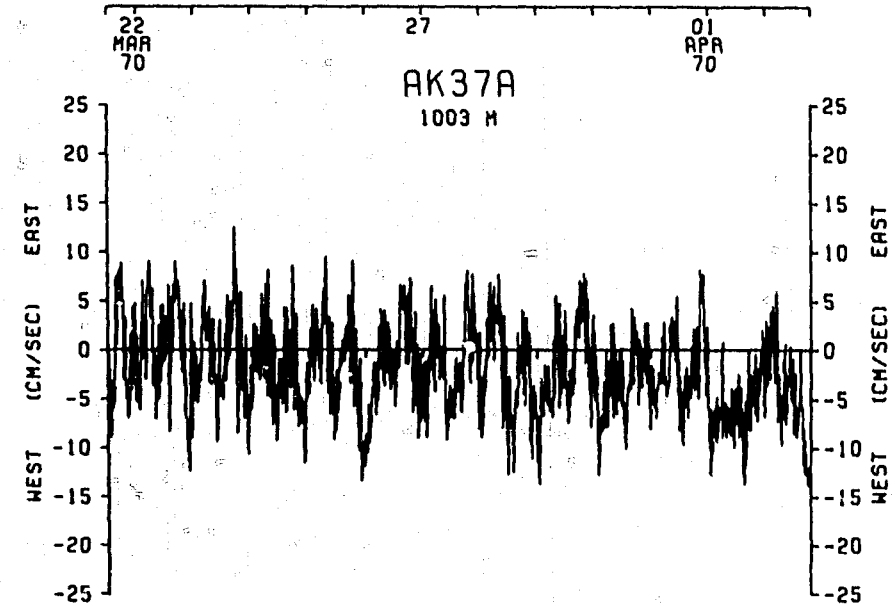
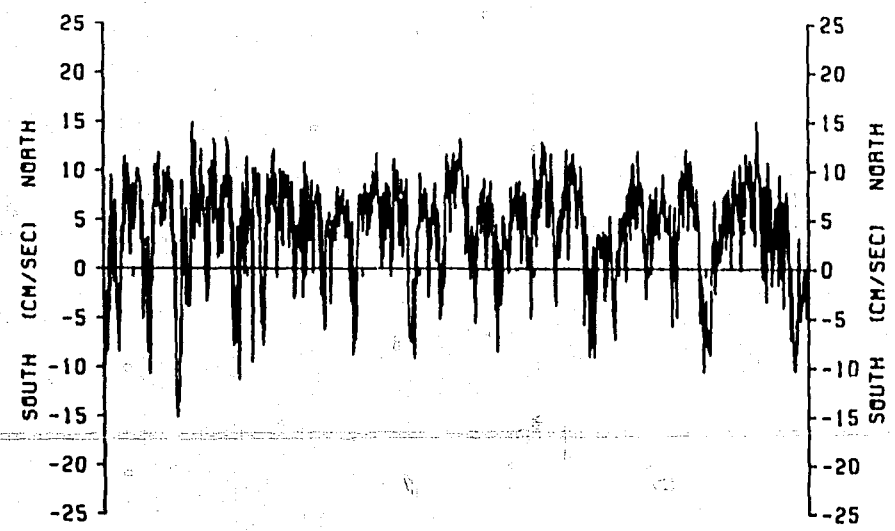

AK37A
 GEODYNE



AK41

50 M

70- 111-21 TO 70- 111-25

AK41
ALEXAEV

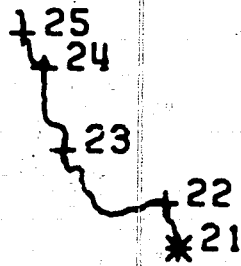

TIME HISTOGRAM

DIRECTION DEGREES	DATA/ AK41	TIME	SPEED M/SEC
0	360	212230	5 5 85 5 85
85	5	220130	33 36 86 3
3	3 3 6 3 6 3	220430	7 38 6 86 3
5	3 3 36 83 3	220730	49 42 4
30	5 5555 58555	221030	58 552 2
855	3 3 6 3 6 3	221330	22 52 528
58 58 5	5 5 5 5 5 8 8	221630	3 8 6 3 3 8 3
8	5 5 5 5 5 5 5 5	221930	7 827 2
63	5 5 5 5 855 88	222230	8 585 85 8 5
6 633	3 3 33338	230130	2 82 225 22
368	3 3 3 83	230430	5 58 55 558 5 5
3682 3	3 3 333	230730	2 78 225
386 3	3 3333	231030	2 7 25 82
3 36 3 3 3	3 3333	231330	23 55 52
5 5 5	5 55 558 5	231630	5 3 5 52 2
85	5 5 5 5 5 5 5 5	231930	86 8
636	5 5 5 5 5 5 5 5	232230	3 89 633 3
8 8 5	5 5 5 5 5 5 5 5	240130	5 77 8
638 3	5 5 5 5 5 5 5 5	240430	7 78 22
33383 3	5 5 5 5 5 5 5 5	240730	66 688 3
6 8	5 5 5 5 5 5 5 5	241030	2 457 5
83	5 5 5 5 5 5 5 5	241330	2 268 22
5 5	5 5 5 5 5 5 5 5	241630	29 8
0	360	241930	5 38 1
0	360	242230	88 24
0	360	250130	4 662 2
0	360	250430	82 2
0	360	250730	3 83 3
0	360	251030	5 81
0	360	251330	8 12 2

DATA/ AK41
 SAMPLE SIZE • 10800-000 SECONDS
 SPANNING RANGE
 FROM 70-111-21 21-00-00
 TO 70-111-25 15-15-00
 AVERAGE NUMBER ELEMENTS/SAMPLE • 12
 TOTAL NUMBER OF DATA SAMPLES • 30
 NUMBER OF VACUOUS DATA SAMPLES • 0
 NUMBER OF NON-STANDARD RECORDS • 0
 JOB END/ 1912F OCT 07, 1970

AK41
 ALEXAEV

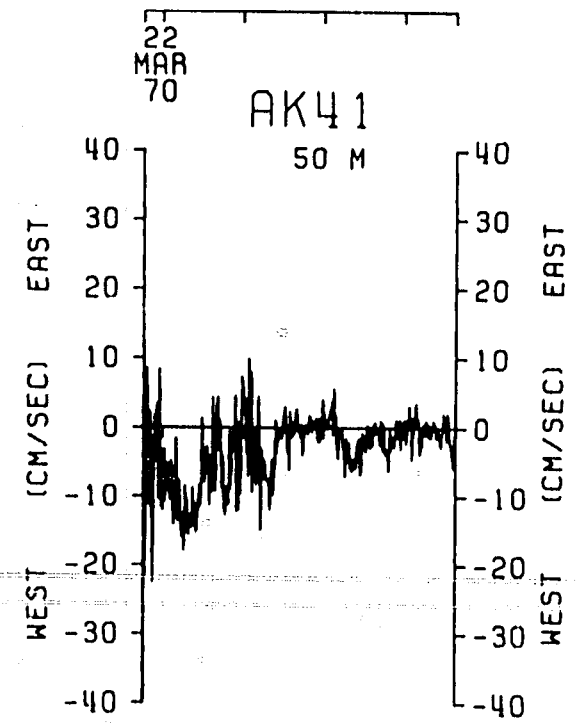
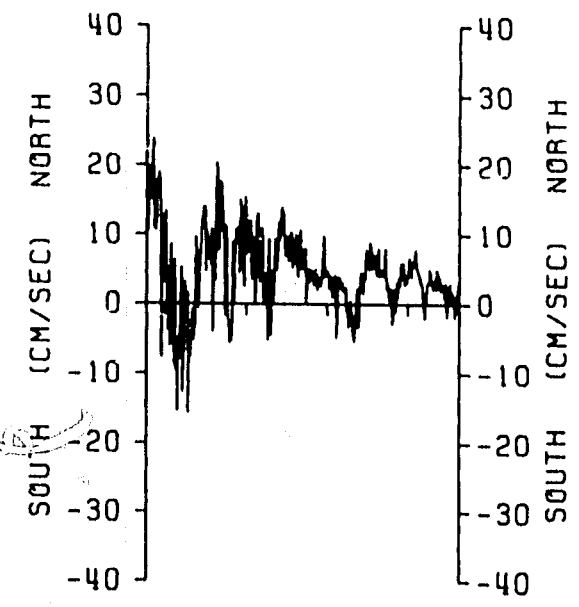

STAT506

E = EAST
N = NORTH

UNITS = MM/SEC
UNITS = MM/SEC

SPEED

UNITS = MM/SEC

DATE	MO	DA	HR	MIN	SEC	MEAN (E)	MEAN (N)	VECTOR MEAN	VARIANCE (E)	VARIANCE (N)	VECTOR VARIANCE	COVARIANCE (E & N)	MEAN (E)	VARIANCE (E)
70-	III-	22	12	01	16	113.	79.	136.	6600.27	6606.51	5625.39	2891.01	162.	3336.67
70-	III-	23	12	01	16	05.	163.	169.	7025.09	5910.75	6669.92	3166.39	220.	2108.66
70-	III-	24	12	01	16	63.	97.	116.	6835.65	9700.13	8297.89	3681.72	171.	3386.08
70-	III-	25	12	01	16	08.	109.	119.	5058.89	6045.90	5762.39	3660.07	151.	3111.91
70-	III-	26	12	01	16	53.	133.	100.	3076.13	3372.03	3220.08	1377.83	162.	2177.63
70-	III-	27	12	01	16	56.	121.	133.	5672.36	5893.03	5882.69	2021.10	145.	3260.87
70-	III-	28	12	01	16	111.	149.	186.	3080.27	8110.49	5799.38	2356.31	209.	0227.88
70-	III-	29	12	01	16	113.	81.	129.	2920.51	6902.16	3935.33	1187.80	169.	1705.53
70-	III-	30	12	01	16	62.	60.	70.	2581.90	3396.77	2989.35	1409.97	110.	1700.76
70-	III-	31	12	01	16	23.	31.	38.	3011.70	3127.35	3069.52	960.77	75.	1217.03
70-	IV	01	12	01	16	27.	21.	30.	5210.15	3619.98	4015.06	166.53	89.	1700.27

STAT506

*** EAST ***
*** MM/SEC ***

MEAN . 66.05 STD ERR . 2.22
VARIANCE . 5698.51
STD. DEV. . 74.15
KURTOSIS . 2.66
SKEWNESS . .080

*** NORTH ***
*** MM/SEC ***

MEAN . 95.00 STD ERR . 2.72
VARIANCE . 7603.61
STD. DEV. . 87.20
KURTOSIS . 2.91
SKEWNESS . .109

*** SPEED ***
*** MM/SEC ***

MEAN . 149.64 STD ERR . 2.02
VARIANCE . 6170.97
STD. DEV. . 60.01
KURTOSIS . 2.68
SKEWNESS . .170

*** EAST & NORTH ***
***** MM/SEC *****

COVARIANCE . 1405.59 STD ERR . 305.07
STD. DEV. OF COVARIANCE . 9762.39
CORRELATION COEFFICIENT . .279

***** VECTOR MEANS *****
***** EAST & NORTH *****

MEAN . 116.03
VARIANCE . 6591.06
STD. DEV. . 80.90

SAMPLE SIZE . 1024 POINTS



0 50
KILOMETERS

AK42A

53 M

70- III-21 TO 70- IV -03

PERIOD, HOURS

KIN. ENERGY DENSITY
CM²/SEC²
C.P.H.

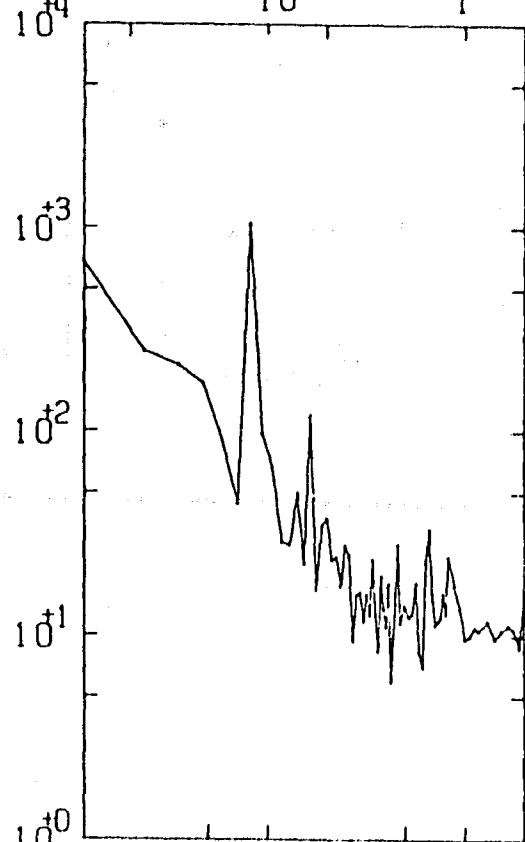

FREQUENCY, CYCLES/HR

AK42A

GEODYNE

TIME PREFIX=

.....

TIME
0000
0001
0002
0003
0004
0005
0006
0007
0008
0009
0010
0011
0012
0013
0014
0015
0016
0017
0018
0019
0020
0021
0022
0023
0024
0025
0026
0027
0028
0029
0030
0031
0032
0033
0034
0035
0036
0037
0038
0039
0040
0041
0042
0043
0044
0045
0046
0047
0048
0049
0050
0051
0052
0053
0054
0055
0056
0057
0058
0059
0100
0101
0102
0103
0104
0105
0106
0107
0108
0109
0110
0111
0112
0113
0114
0115
0116
0117
0118
0119
0120
0121
0122
0123
0124
0125
0126
0127
0128
0129
0130
0131
0132
0133
0134
0135
0136
0137
0138
0139
0140
0141
0142
0143
0144
0145
0146
0147
0148
0149
0150
0151
0152
0153
0154
0155
0156
0157
0158
0159
0200
0201
0202
0203
0204
0205
0206
0207
0208
0209
0210
0211
0212
0213
0214
0215
0216
0217
0218
0219
0220
0221
0222
0223
0224
0225
0226
0227
0228
0229
0230
0231
0232
0233
0234
0235
0236
0237
0238
0239
0240
0241
0242
0243
0244
0245
0246
0247
0248
0249
0250
0251
0252
0253
0254
0255
0256
0257
0258
0259
0300
0301
0302
0303
0304
0305
0306
0307
0308
0309
0310
0311
0312
0313
0314
0315
0316
0317
0318
0319
0320
0321
0322
0323
0324
0325
0326
0327
0328
0329
0330
0331
0332
0333
0334
0335
0336
0337
0338
0339
0340
0341
0342
0343
0344
0345
0346
0347
0348
0349
0350
0351
0352
0353
0354
0355
0356
0357
0358
0359
0400
0401
0402
0403
0404
0405
0406
0407
0408
0409
0410
0411
0412
0413
0414
0415
0416
0417
0418
0419
0420
0421
0422
0423
0424
0425
0426
0427
0428
0429
0430
0431
0432
0433
0434
0435
0436
0437
0438
0439
0440
0441
0442
0443
0444
0445
0446
0447
0448
0449
0450
0451
0452
0453
0454
0455
0456
0457
0458
0459
0500
0501
0502
0503
0504
0505
0506
0507
0508
0509
0510
0511
0512
0513
0514
0515
0516
0517
0518
0519
0520
0521
0522
0523
0524
0525
0526
0527
0528
0529
0530
0531
0532
0533
0534
0535
0536
0537
0538
0539
0540
0541
0542
0543
0544
0545
0546
0547
0548
0549
0550
0551
0552
0553
0554
0555
0556
0557
0558
0559
0600
0601
0602
0603
0604
0605
0606
0607
0608
0609
0610
0611
0612
0613
0614
0615
0616
0617
0618
0619
0620
0621
0622
0623

STATS

E = EAST
N = NORTH
UNITS = MM/SEC
UNITS = MM/SEC

DATE	MID TIME			MEAN		VECT9R	VARIANCE	VARIANCE	VECT9R	COVARIANCE	SPEED	
	HR	MIN	SEC	(E)	(N)						UNITS	VARIANCE
70-111-22	12	0		86	59	63	18638.70	7572.76	13105.73	-379.52	169	1133.78
70-111-23	12	0		169	85	171	3725.22	2360.26	3000.76	95.50	185	1231.26
70-111-24	12	0		69	8	69	8701.90	5093.01	6992.65	1348.29	130	1573.96
70-111-25	12	0		136	40	130	3846.69	1976.00	2931.35	-17.45	151	1363.75
70-111-26	12	0		99	3	39	6200.56	3539.38	5871.96	417.96	138	2365.16
70-111-27	12	0		75	73	105	4790.29	5696.13	5245.21	-2390.51	141	1497.53
70-111-28	12	0		108	43	110	1801.25	3753.00	2777.33	85.45	139	667.47
70-111-29	12	0		87	40	96	1727.95	1769.98	1746.97	528.37	111	371.44
70-111-30	12	0		99	105	145	3008.02	2431.87	2719.95	1171.29	140	727.18
70-111-31	12	0		81	60	100	3490.09	4318.39	3900.24	2040.46	132	1300.47
70-IV-1	12	0		57	98	113	3876.78	2545.57	3210.15	556.50	100	702.73

STATS

*** EAST ***
*** MM/SEC ***

MEAN = 86.72 STD ERR = 2.58
VARIANCE = 6798.04
STD. DEV. = 82.45
KURTOSIS = 0.29
SKEWNESS = 1.255

*** NORTH ***
*** MM/SEC ***

MEAN = 59.59 STD ERR = 2.24
VARIANCE = 5100.39
STD. DEV. = 71.72
KURTOSIS = 2.75
SKEWNESS = -0.420

*** SPEED ***
*** MM/SEC ***

MEAN = 145.26 STD ERR = 1.20
VARIANCE = 1568.29
STD. DEV. = 39.60
KURTOSIS = 2.61
SKEWNESS = 0.389

*** EAST & NORTH ***
*** MM/SEC ***

COVARIANCE = 118.03 STD ERR = 274.00
STD. DEV. OF COVARIANCE = 8768.12
CORRELATION COEFFICIENT = 0.020

***** VECTOR MEANS *****
***** EAST & NORTH *****

MEAN = 103.97
VARIANCE = 5971.21
STD. DEV. = 77.27

SAMPLE SIZE = 1024 POINTS

0 30
KILOMETERS

AK43

196 M

70-111-21 TO 70-IV-01

AK43
LSK

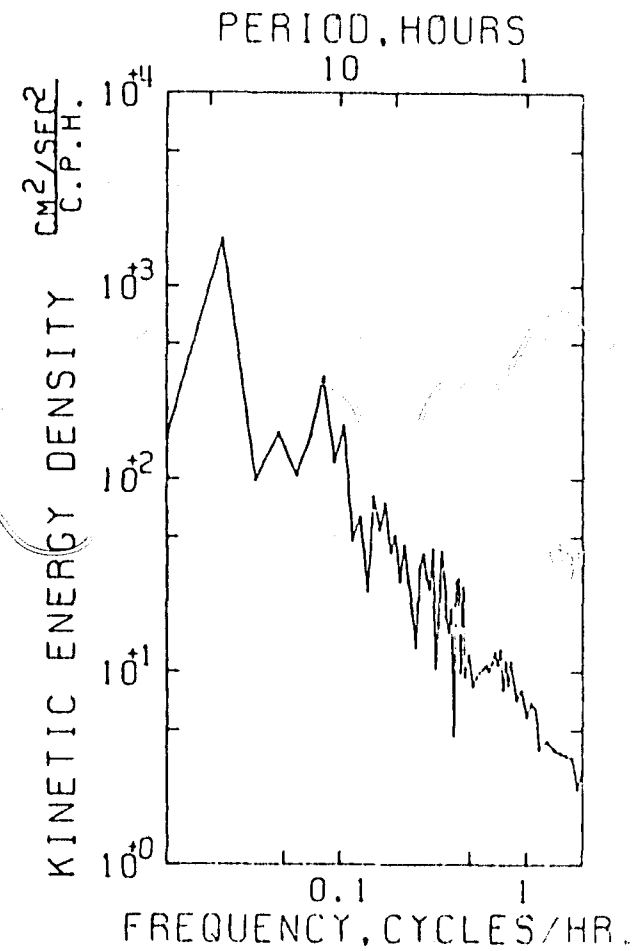

STATS

DATE	MID TIME			MEAN		VECTOR MEAN	VARIANCE (E)	VARIANCE (N)	VECTOR VARIANCE (E & N)	COVARIANCE (E & N)	SPEED	
	HR	MIN	SEC	(E)	(N)						MEAN (E & N)	VARIANCE (E & N)
70- 111-22	12	0	3	-58.	95.	110.	15863.25	15219.19	15541.22	1179.62	191.	6560.96
70- 111-23	12	0	3	-153.	60.	16.	9750.00	15679.81	12716.91	1330.67	21.	6818.71
70- 111-24	12	0	0	-9.	13.	95.	15838.99	13478.26	15658.63	4919.87	170.	11416.67
70- 111-25	12	0	0	-148.	139.	23.	10558.85	5844.68	8100.55	893.22	229.	4937.66
70- 111-26	12	0	3	-112.	-8.	112.	12701.00	6411.67	9550.23	-538.23	150.	9258.11
70- 111-27	12	0	3	-105.	79.	121.	9263.20	8798.05	8031.63	-3608.39	154.	9578.67
70- 111-28	12	0	3	-114.	66.	132.	5266.83	9239.87	6752.36	-68.12	158.	6027.51
70- 111-29	12	0	3	-108.	42.	116.	4272.53	9580.66	4926.68	325.68	138.	4267.09
70- 111-30	12	0	3	-130.	120.	176.	6028.00	8795.67	6413.73	859.16	202.	3177.73
70- 111-31	12	0	0	-118.	56.	129.	10867.45	12133.19	11490.52	3029.85	178.	7831.90
70- IV - 1	12	0	3	-83.	127.	151.	7309.99	7711.38	7510.68	513.95	203.	4254.59

STATS

*** EAST ***
 *** MM/SEC ***
 MEAN * -111.39 STD ERR * 3.22
 VARIANCE * 10600.05
 STD. DEV. * 103.17
 KURTOSIS * 2.90
 SKEWNESS * 0.10

*** NORTH ***
 *** MM/SEC ***
 MEAN * 72.12 STD ERR * 3.30
 VARIANCE * 11705.96
 STD. DEV. * 108.19
 KURTOSIS * 2.61
 SKEWNESS * -0.15

*** SPEED ***
 *** MM/SEC ***
 MEAN * 179.06 STD ERR * 2.73
 VARIANCE * 7601.14
 STD. DEV. * 87.22
 KURTOSIS * 2.12
 SKEWNESS * -0.11

*** EAST & NORTH ***
 ***** MM/SEC *****
 COVARIANCE * -36.79 STD ERR * 53.28
 STD. DEV. OF COVARIANCE * 17097.12
 CORRELATION COEFFICIENT * 0.257

***** VECTOR MEANS *****
 ***** EAST & NORTH *****
 MEAN * 132.70
 VARIANCE * 11175.17
 STD. DEV. * 105.71

SAMPLE SIZE * 1.20 POINTS

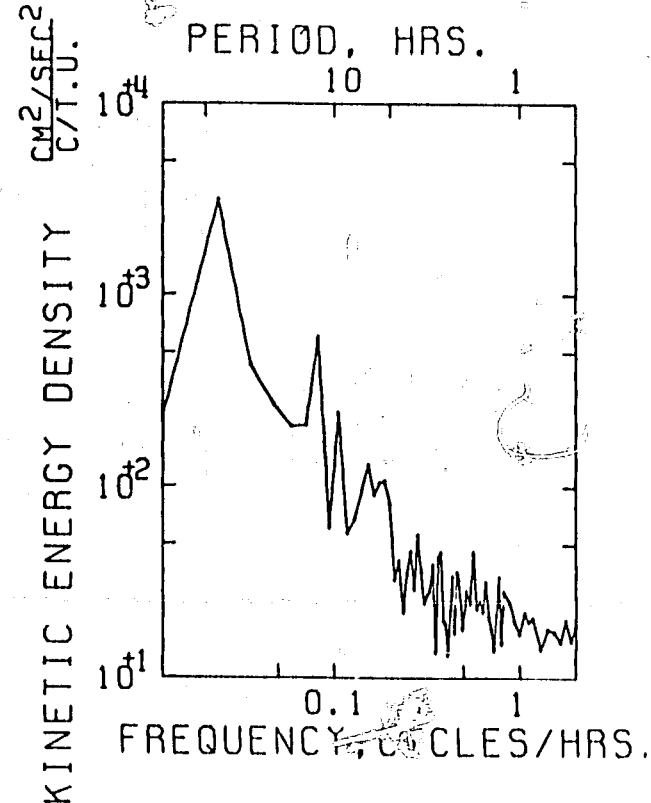
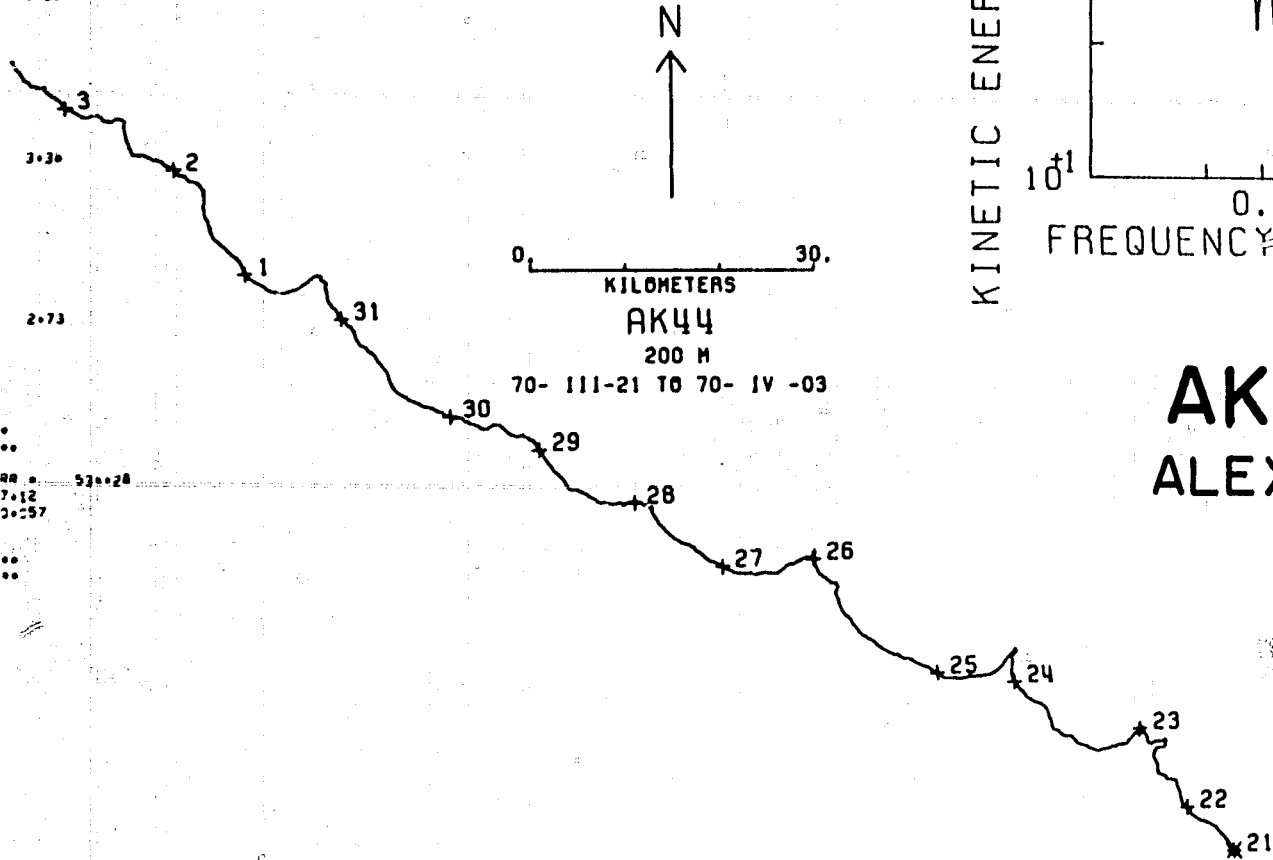

AK44
ALEXAEV

STATS

E = EAST
N = NORTH

DATE	MID TIME			MEAN		VECTOR MEAN	VARIANCE (E)	VARIANCE (N)	VECTOR VARIANCE	COVARIANCE (E & N)	SPEED	
	MM	MIN	SEC	(E)	(N)						MEAN	VARIANCE
70- 111-22	12	0	27	-66.	117.	130.	1929.70	10229.29	17703.29	1201.76	270.	437.03
70- 111-23	12	0	27	-108.	64.	159.	10353.03	17262.78	13807.91	1299.13	228.	802.92
70- 111-24	12	0	27	-87.	11.	88.	10229.40	13783.00	11991.20	3682.35	179.	1120.66
70- 111-25	12	0	27	-121.	104.	141.	4558.15	3677.78	4016.66	1239.95	182.	872.50
70- 111-26	12	0	27	-106.	..	104.	6430.66	8291.00	7360.73	318.19	157.	1211.01
70- 111-27	12	0	27	-89.	97.	132.	6272.93	6486.26	6379.58	512.23	171.	790.71
70- 111-28	12	0	27	-61.	163.	168.	28.03	398.90	211.97	-99.92	160.	423.93
70- 111-29	12	0	27	-38.	146.	150.	150.41	741.94	446.17	112.06	152.	418.83
70- 111-30	12	0	27	-43.	171.	177.	22.55	359.38	190.97	-90.02	177.	381.94
70- 111-31	12	0	27	-39.	156.	161.	55.33	881.65	468.89	-220.90	161.	937.19
70- IV - 1	12	0	27	-61.	163.	168.	119.02	1067.06	793.00	-416.66	179.	598.76

STATS

*** EAST ***
*** M/SEC ***
MEAN = 75.25 STD ERR = 2.56
VARIANCE = 6487.77
STD. DEV. = 81.74
KURTOSIS = 6.93
SKEWNESS = 1.226

*** NORTH ***
*** M/SEC ***
MEAN = 107.01 STD ERR = 3.08
VARIANCE = 573.66
STD. DEV. = 23.95
KURTOSIS = 0.14
SKEWNESS = -1.362

*** SPEED ***
*** M/SEC ***
MEAN = 179.66 STD ERR = 1.16
VARIANCE = 136.00
STD. DEV. = 11.66
KURTOSIS = 2.01
SKEWNESS = 0.437

*** EAST ***
***** M/SEC *****
COVARIANCE = 425.09 STD ERR = 23.02
STD. DEV. OF COVARIANCE = 10573.76
CORRELATION COEFFICIENT = 3.279

***** VECTOR MEAN *****
***** EAST & NORTH *****

MEAN = 131.31
VARIANCE = 3210.11
STD. DEV. = 56.65

SAMPLE SIZE = 102 POINTS

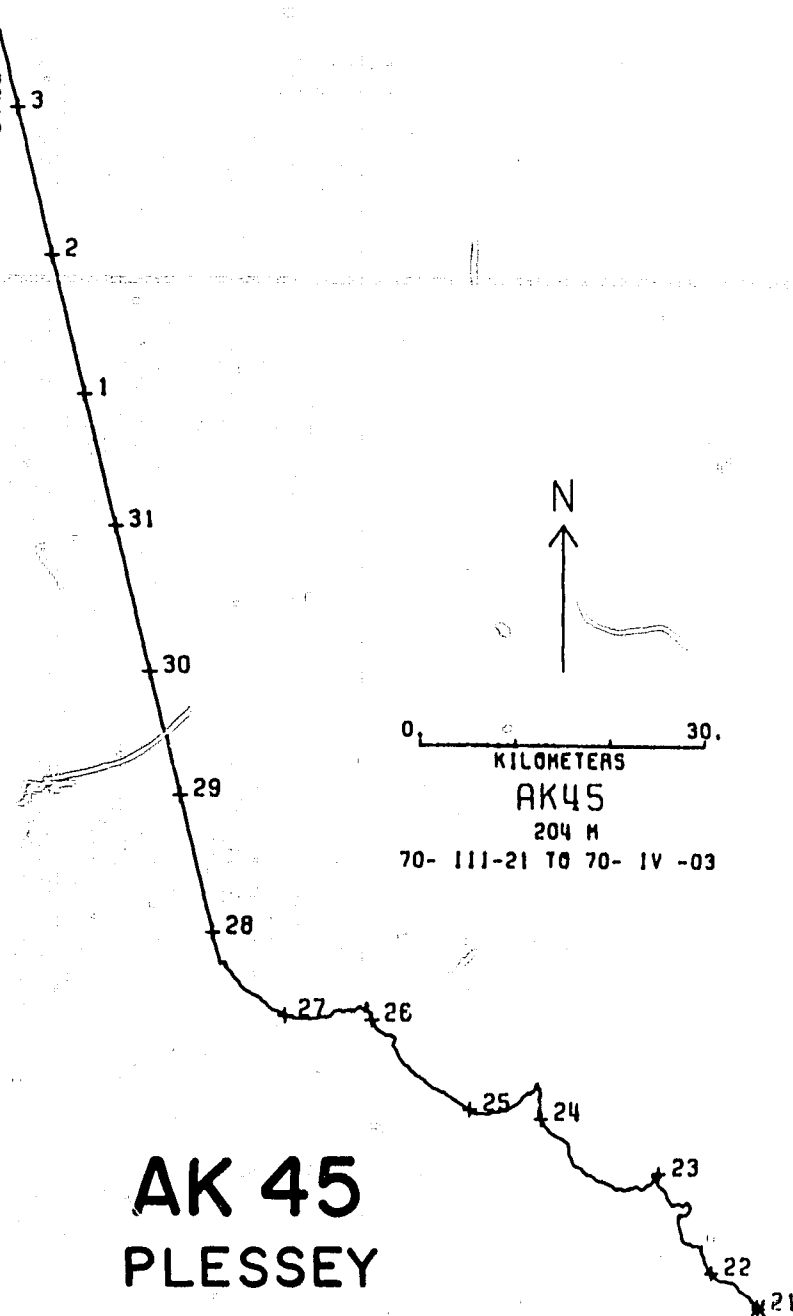
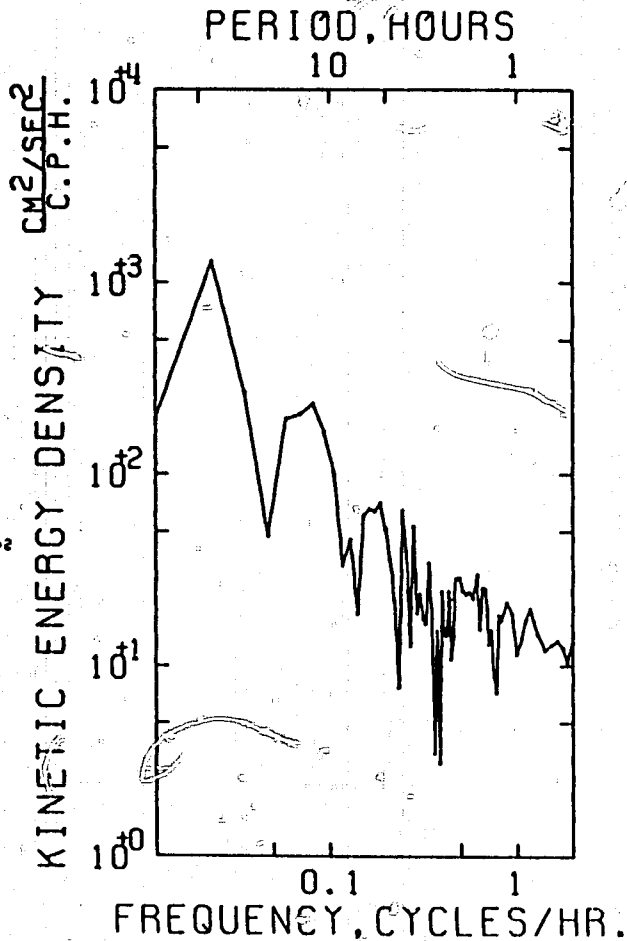

TIME	SPEED	TIME	SPEED
01:00	0.0	01:00	0.0
01:05	0.0	01:05	0.0
01:10	0.0	01:10	0.0
01:15	0.0	01:15	0.0
01:20	0.0	01:20	0.0
01:25	0.0	01:25	0.0
01:30	0.0	01:30	0.0
01:35	0.0	01:35	0.0
01:40	0.0	01:40	0.0
01:45	0.0	01:45	0.0
01:50	0.0	01:50	0.0
01:55	0.0	01:55	0.0
02:00	0.0	02:00	0.0
02:05	0.0	02:05	0.0
02:10	0.0	02:10	0.0
02:15	0.0	02:15	0.0
02:20	0.0	02:20	0.0
02:25	0.0	02:25	0.0
02:30	0.0	02:30	0.0
02:35	0.0	02:35	0.0
02:40	0.0	02:40	0.0
02:45	0.0	02:45	0.0
02:50	0.0	02:50	0.0
02:55	0.0	02:55	0.0
03:00	0.0	03:00	0.0
03:05	0.0	03:05	0.0
03:10	0.0	03:10	0.0
03:15	0.0	03:15	0.0
03:20	0.0	03:20	0.0
03:25	0.0	03:25	0.0
03:30	0.0	03:30	0.0
03:35	0.0	03:35	0.0
03:40	0.0	03:40	0.0
03:45	0.0	03:45	0.0
03:50	0.0	03:50	0.0
03:55	0.0	03:55	0.0
04:00	0.0	04:00	0.0
04:05	0.0	04:05	0.0
04:10	0.0	04:10	0.0
04:15	0.0	04:15	0.0
04:20	0.0	04:20	0.0
04:25	0.0	04:25	0.0
04:30	0.0	04:30	0.0
04:35	0.0	04:35	0.0
04:40	0.0	04:40	0.0
04:45	0.0	04:45	0.0
04:50	0.0	04:50	0.0
04:55	0.0	04:55	0.0
05:00	0.0	05:00	0.0
05:05	0.0	05:05	0.0
05:10	0.0	05:10	0.0
05:15	0.0	05:15	0.0
05:20	0.0	05:20	0.0
05:25	0.0	05:25	0.0
05:30	0.0	05:30	0.0
05:35	0.0	05:35	0.0
05:40	0.0	05:40	0.0
05:45	0.0	05:45	0.0
05:50	0.0	05:50	0.0
05:55	0.0	05:55	0.0
06:00	0.0	06:00	0.0
06:05	0.0	06:05	0.0
06:10	0.0	06:10	0.0
06:15	0.0	06:15	0.0
06:20	0.0	06:20	0.0
06:25	0.0	06:25	0.0
06:30	0.0	06:30	0.0
06:35	0.0	06:35	0.0
06:40	0.0	06:40	0.0
06:45	0.0	06:45	0.0
06:50	0.0	06:50	0.0
06:55	0.0	06:55	0.0
07:00	0.0	07:00	0.0
07:05	0.0	07:05	0.0
07:10	0.0	07:10	0.0
07:15	0.0	07:15	0.0
07:20	0.0	07:20	0.0
07:25	0.0	07:25	0.0
07:30	0.0	07:30	0.0
07:35	0.0	07:35	0.0
07:40	0.0	07:40	0.0
07:45	0.0	07:45	0.0
07:50	0.0	07:50	0.0
07:55	0.0	07:55	0.0
08:00	0.0	08:00	0.0
08:05	0.0	08:05	0.0
08:10	0.0	08:10	0.0
08:15	0.0	08:15	0.0
08:20	0.0	08:20	0.0
08:25	0.0	08:25	0.0
08:30	0.0	08:30	0.0
08:35	0.0	08:35	0.0
08:40	0.0	08:40	0.0
08:45	0.0	08:45	0.0
08:50	0.0	08:50	0.0
08:55	0.0	08:55	0.0
09:00	0.0	09:00	0.0
09:05	0.0	09:05	0.0
09:10	0.0	09:10	0.0
09:15	0.0	09:15	0.0
09:20	0.0	09:20	0.0
09:25	0.0	09:25	0.0
09:30	0.0	09:30	0.0
09:35	0.0	09:35	0.0
09:40	0.0	09:40	0.0
09:45	0.0	09:45	0.0
09:50	0.0	09:50	0.0
09:55	0.0	09:55	0.0
10:00	0.0	10:00	0.0
10:05	0.0	10:05	0.0
10:10	0.0	10:10	0.0
10:15	0.0	10:15	0.0
10:20	0.0	10:20	0.0
10:25	0.0	10:25	0.0
10:30	0.0	10:30	0.0
10:35	0.0	10:35	0.0
10:40	0.0	10:40	0.0
10:45	0.0	10:45	0.0
10:50	0.0	10:50	0.0
10:55	0.0	10:55	0.0
11:00	0.0	11:00	0.0
11:05	0.0	11:05	0.0
11:10	0.0	11:10	0.0
11:15	0.0	11:15	0.0
11:20	0.0	11:20	0.0
11:25	0.0	11:25	0.0
11:30	0.0	11:30	0.0
11:35	0.0	11:35	0.0
11:40	0.0	11:40	0.0
11:45	0.0	11:45	0.0
11:50	0.0	11:50	0.0
11:55	0.0	11:55	0.0
12:00	0.0	12:00	0.0
12:05	0.0	12:05	0.0
12:10	0.0	12:10	0.0
12:15	0.0	12:15	0.0
12:20	0.0	12:20	0.0
12:25	0.0	12:25	0.0
12:30	0.0	12:30	0.0
12:35	0.0	12:35	0.0
12:40	0.0	12:40	0.0
12:45	0.0	12:45	0.0
12:50	0.0	12:50	0.0
12:55	0.0	12:55	0.0
13:00	0.0	13:00	0.0
13:05	0.0	13:05	0.0
13:10	0.0	13:10	0.0
13:15	0.0	13:15	0.0
13:20	0.0	13:20	0.0
13:25	0.0	13:25	0.0
13:30	0.0	13:30	0.0
13:35	0.0	13:35	0.0
13:40	0.0	13:40	0.0
13:45	0.0	13:45	0.0
13:50	0.0	13:50	0.0
13:55	0.0	13:55	0.0
14:00	0.0	14:00	0.0
14:05	0.0	14:05	0.0
14:10	0.0	14:10	0.0
14:15	0.0	14:15	0.0
14:20	0.0	14:20	0.0
14:25	0.0	14:25	0.0
14:30	0.0	14:30	0.0
14:35	0.0	14:35	0.0
14:40	0.0	14:40	0.0
14:45	0.0	14:45	0.0
14:50	0.0	14:50	0.0
14:55	0.0	14:55	0.0
15:00	0.0	15:00	0.0
15:05	0.0	15:05	0.0
15:10	0.0	15:10	0.0
15:15	0.0	15:15	0.0
15:20	0.0	15:20	0.0
15:25	0.0	15:25	0.0
15:30	0.0	15:30	0.0
15:35	0.0	15:35	0.0
15:40	0.0	15:40	0.0
15:45	0.0	15:45	0.0
15:50	0.0	15:50	0.0
15:55	0.0	15:55	0.0
16:00	0.0	16:00	0.0
16:05	0.0	16:05	0.0
16:10	0.0	16:10	0.0
16:15	0.0	16:15	0.0
16:20	0.0	16:20	0.0
16:25	0.0	16:25	0.0
16:30	0.0	16:30	0.0
16:35	0.0	16:35	0.0
16:40	0.0	16:40	0.0
16:45	0.0	16:45	0.0
16:50	0.0	16:50	0.0
16:55	0.0	16:55	0.0
17:00	0.0	17:00	0.0
17:05	0.0	17:05	0.0
17:10	0.0	17:10	0.0
17:15	0.0	17:15	0.0
17:20	0.0	17:20	0.0
17:25	0.0	17:25	0.0
17:30	0.0	17:30	0.0
17:35	0.0	17:35	0.0
17:40	0.0	17:40	0.0
17:45	0.0	17:45	0.0
17:50	0.0	17:50	0.0
17:55	0.0	17:55	0.0
18:00	0.0	18:00	0.0
18:05	0.0	18:05	0.0
18:10	0.0	18:10	0.0
18:15	0.0	18:15	0.0
18:20	0.0	18:20	0.0
18:25	0.0	18:25	0.0
18:30	0.0	18:30	0.0
18:35	0.0	18:35	0.0
18:40	0.0	18:40	0.0
18:45	0.0	18:45	0.0
18:50	0.0	18:50	0.0
18:55	0.0	18:55	0.0
19:00	0.0	19:00	0.0
19:05	0.0	19:05	0.0
19:10	0.0	19:10	0.0
19:15	0.0	19:15	0.0
19:20	0.0	19:20	0.0
19:25	0.0	19:25	0.0
19:30	0.0	19:30	0.0
19:35	0.0	19:35	0.0
19:40	0.0	19:40	0.0
19:45	0.0	19:45	0.0
19:50	0.0	19:50	0.0
19:55	0.0	19:55	0.0
20:00	0.0	20:00	0.0
20:05	0.0	20:05	0.0
20:10	0.0	20:10	0.0
20:15	0.0	20:15	0.0
20:20	0.0	20:20	0.0
20:25	0.0	20:25	0.0
20:30	0.0	20:30	0.0
20:35	0.0	20:35	0.0
20:40	0.0	20:40	0.0
20:45	0.0	20:45	0.0
20:50	0.0	20:50	0.0
20:55	0.0	20:55	0.0
21:00	0.0	21:00	0.0
21:05	0.0	21:05	0.0
21:10	0.0	21:10	0.0
21:15	0.0	21:15	0.0
21:20	0.0	21:20	0.0
21:25	0.0	21:25	0.0
21:30	0.0	21:30	0.0
21:35	0.0	21:35	0.0
21:40	0.0	21:40	0.0
21:45	0.0	21:45	0.0
21:50	0.0	21:50	0.0
21:55	0.0	21:55	0.0
22:00	0.0	22:00	0.0
22:05	0.0	22:05	0.0
22:10	0.0	22:10	0.0
22:15	0.0	22:15	0.0
22:20	0.0	22:20	0.0
22:25	0.0	22:25	0.0
22:30	0.0	22:30	0.0
22:35	0.0	22:35	0.0
22:40	0.0	22:40	0.0
22:45	0.0	22:45	0.0
22:50	0.0	22:50	0.0
22:55	0.0	22:55	0.0
23:00	0.0	23:00	0.0
23:05	0.0	23:05	0.0
23:10	0.0	23:10	0.0
23:15	0.0	23:15	0.0
23:20	0.0	23:20	0.0
23:25	0.0	23:25	0.0
23:30	0.0	23:30	0.0
23:35	0.0	23:35	0.0
23:40	0.0	23:40	0.0
23:45	0.0	23:45	0.0
23:50	0.0	23:50	0.0
23:55	0.0	23:55	0.0
00:00	0.0	00:00	0.0
00:05	0.0	00:05	0.0
00:10	0.0	00:10	0.0
00:15	0.0	00:15	0.0
00:20	0.0	00:20	0.0
00:25	0.0	00:25	0.0
00:30	0.0	00:30	0.0
00:35	0.0	00:35	0.0
00:40	0.0	00:40	0.0
00:45	0.0	00:45	0.0
00:50	0.0	00:50	0.0
00:55	0.0	00:55	0.0
01:00	0.0	01:00	0.0

DATA 4405
 SAMPLE SIZE = 1700000 SAMPLES
 SPAN IN RANGE
 FROM 7.0 111-21 01-30-27
 TO 7.0 11-22 10-10-27
 AVERAGE NUMBER OF SAMPLES = 12
 TOTAL NUMBER OF DATA SAMPLES = 171
 NUMBER OF DATA SAMPLES PER HOUR = 6
 NUMBER OF DATA SAMPLES PER DAY = 144

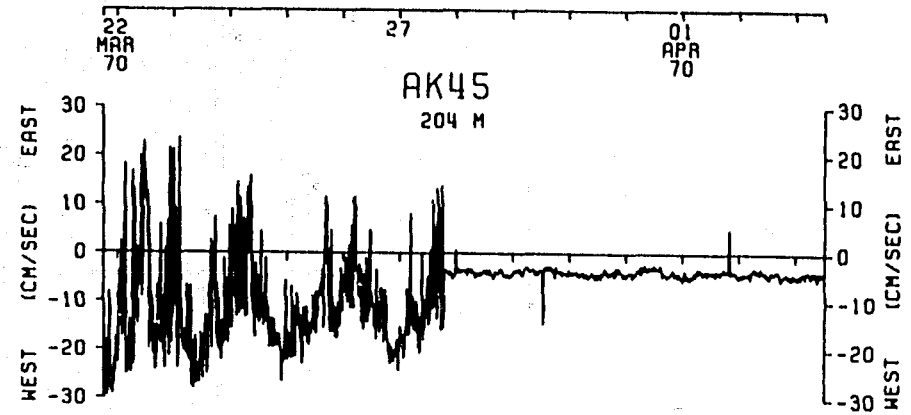
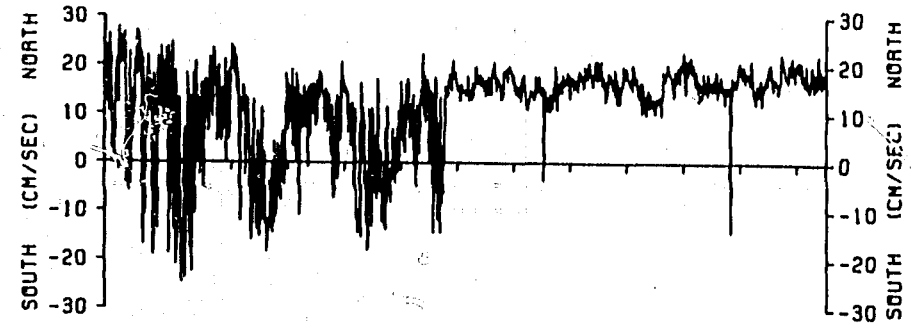

AK45
PLESSEY

STATS		UNITS		MEAN		VECTOR		VARIANCE		VECTOR		COVARIANCE		SPEED	
E	N	HR	MIN	SEC	(E)	(N)	MEAN	(E)	(N)	(E)	(N)	(E & N)	(E)	(N)	
70	111	22	12	0	51	16	5	2712.35	2765.23	2738.79	2.92	82	1639.1		
70	111	23	12	0	67	22	7	2222.13	2566.61	339.25	-33.24	96	2555.56		
70	111	24	12	0	69	23	8	676.69	5230.03	6993.78	2408.84	121	1985.58		
70	111	25	12	0	87	33	9	3677.84	3341.69	3529.78	382.07	119	2201.39		
70	111	26	12	0	55	28	8	6751.24	2818.62	2759.94	51.33	114	1809.88		
70	111	27	12	0	45	26	9	3341.04	585.13	4617.40	576.57	126	2730.86		
70	111	28	12	0	67	34	9	625.80	3413.93	4829.86	486.92	125	2889.58		
70	111	29	12	0	67	34	8	3483.04	4825.25	415.16	-311.78	111	2477.60		
70	111	30	12	0	17	39	11	3526.24	3958.05	374.16	1413.42	136	2257.45		
70	111	31	12	0	37	61	7	4391.62	4788.92	4593.27	462.08	110	2184.28		
70	111	31	12	0	127	67	10	678.45	9297.49	6887.97	2982.67	181	2175.95		

STATS
 *** LAST ***
 *** /SEC ***
 MEAN = 0.7013 STD DEV = 2.013
 VARIANCE = 0.72018
 STD DEV = 0.8473
 KURTOSIS = 7.67
 SKEWNESS = 0.9

*** NORTH ***
 *** /SEC ***
 MEAN = 0.6053 STD DEV = 2.033
 VARIANCE = 0.8055
 STD DEV = 0.8975
 KURTOSIS = 7.03
 SKEWNESS = 0.23

*** SPEED ***
 *** /SEC ***
 MEAN = 0.11013 STD DEV = 1.003
 VARIANCE = 0.73981
 STD DEV = 0.8602
 KURTOSIS = 7.03
 SKEWNESS = 0.23

*** EAST & NORTH ***
 COVARIANCE = 57.06 STD ENR = 227.39
 STD DEV OF COVARIANCE = 7242.97
 CORRELATION COEFFICIENT = 0.161

*** EAST & NORTH MEANS ***
 MEAN = 0.000
 VARIANCE = 0.60035
 STD DEV = 0.7747
 SAMPLE SIZE = 102 POINTS

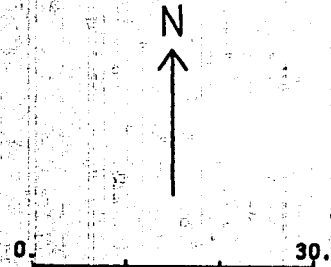

AK46
 1000 M
 70-111-21 TO 70-111-31

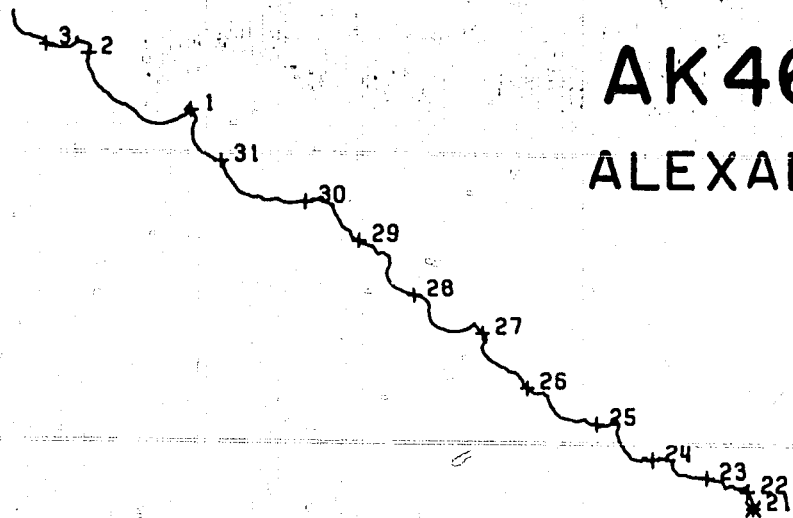
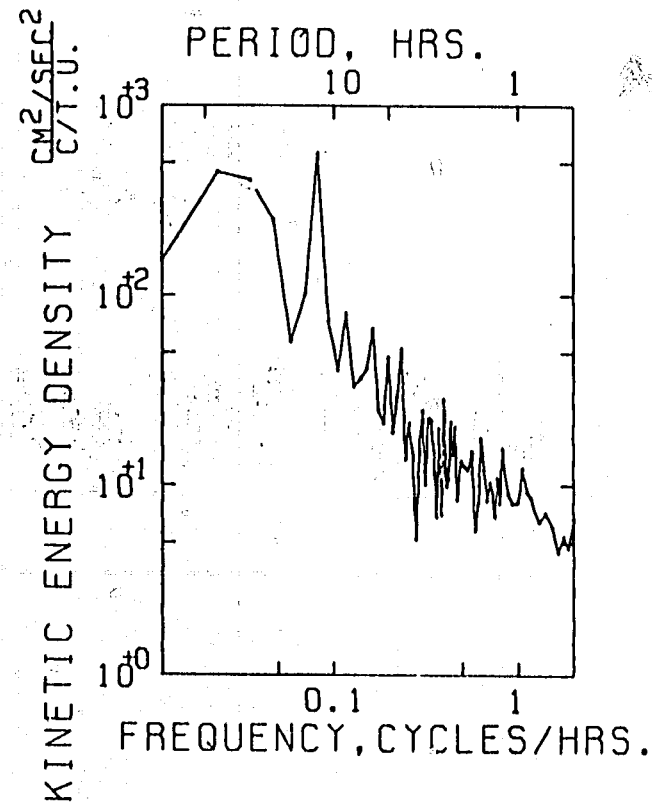

AK46
 ALEXAEV

TIME HISTORIAN DATA 0400 PLATTING BEGINS/ 70- 111-21 21-00-00

DIRECTION	DEGREES	TIME	SPEED
000	000	212030	000
000	000	212130	000
000	000	212230	000
000	000	212330	000
000	000	212430	000
000	000	212530	000
000	000	212630	000
000	000	212730	000
000	000	212830	000
000	000	212930	000
000	000	213030	000
000	000	213130	000
000	000	213230	000
000	000	213330	000
000	000	213430	000
000	000	213530	000
000	000	213630	000
000	000	213730	000
000	000	213830	000
000	000	213930	000
000	000	214030	000
000	000	214130	000
000	000	214230	000
000	000	214330	000
000	000	214430	000
000	000	214530	000
000	000	214630	000
000	000	214730	000
000	000	214830	000
000	000	214930	000
000	000	215030	000
000	000	215130	000
000	000	215230	000
000	000	215330	000
000	000	215430	000
000	000	215530	000
000	000	215630	000
000	000	215730	000
000	000	215830	000
000	000	215930	000
000	000	220030	000
000	000	220130	000
000	000	220230	000
000	000	220330	000
000	000	220430	000
000	000	220530	000
000	000	220630	000
000	000	220730	000
000	000	220830	000
000	000	220930	000
000	000	221030	000
000	000	221130	000
000	000	221230	000
000	000	221330	000
000	000	221430	000
000	000	221530	000
000	000	221630	000
000	000	221730	000
000	000	221830	000
000	000	221930	000
000	000	222030	000
000	000	222130	000
000	000	222230	000
000	000	222330	000
000	000	222430	000
000	000	222530	000
000	000	222630	000
000	000	222730	000
000	000	222830	000
000	000	222930	000
000	000	223030	000
000	000	223130	000
000	000	223230	000
000	000	223330	000
000	000	223430	000
000	000	223530	000
000	000	223630	000
000	000	223730	000
000	000	223830	000
000	000	223930	000
000	000	224030	000
000	000	224130	000
000	000	224230	000
000	000	224330	000
000	000	224430	000
000	000	224530	000
000	000	224630	000
000	000	224730	000
000	000	224830	000
000	000	224930	000
000	000	225030	000
000	000	225130	000
000	000	225230	000
000	000	225330	000
000	000	225430	000
000	000	225530	000
000	000	225630	000
000	000	225730	000
000	000	225830	000
000	000	225930	000
000	000	230030	000
000	000	230130	000
000	000	230230	000
000	000	230330	000
000	000	230430	000
000	000	230530	000
000	000	230630	000
000	000	230730	000
000	000	230830	000
000	000	230930	000
000	000	231030	000
000	000	231130	000
000	000	231230	000
000	000	231330	000
000	000	231430	000
000	000	231530	000
000	000	231630	000
000	000	231730	000
000	000	231830	000
000	000	231930	000
000	000	232030	000
000	000	232130	000
000	000	232230	000
000	000	232330	000
000	000	232430	000
000	000	232530	000
000	000	232630	000
000	000	232730	000
000	000	232830	000
000	000	232930	000
000	000	233030	000
000	000	233130	000
000	000	233230	000
000	000	233330	000
000	000	233430	000
000	000	233530	000
000	000	233630	000
000	000	233730	000
000	000	233830	000
000	000	233930	000
000	000	234030	000
000	000	234130	000
000	000	234230	000
000	000	234330	000
000	000	234430	000
000	000	234530	000
000	000	234630	000
000	000	234730	000
000	000	234830	000
000	000	234930	000
000	000	235030	000
000	000	235130	000
000	000	235230	000
000	000	235330	000
000	000	235430	000
000	000	235530	000
000	000	235630	000
000	000	235730	000
000	000	235830	000
000	000	235930	000
000	000	240030	000

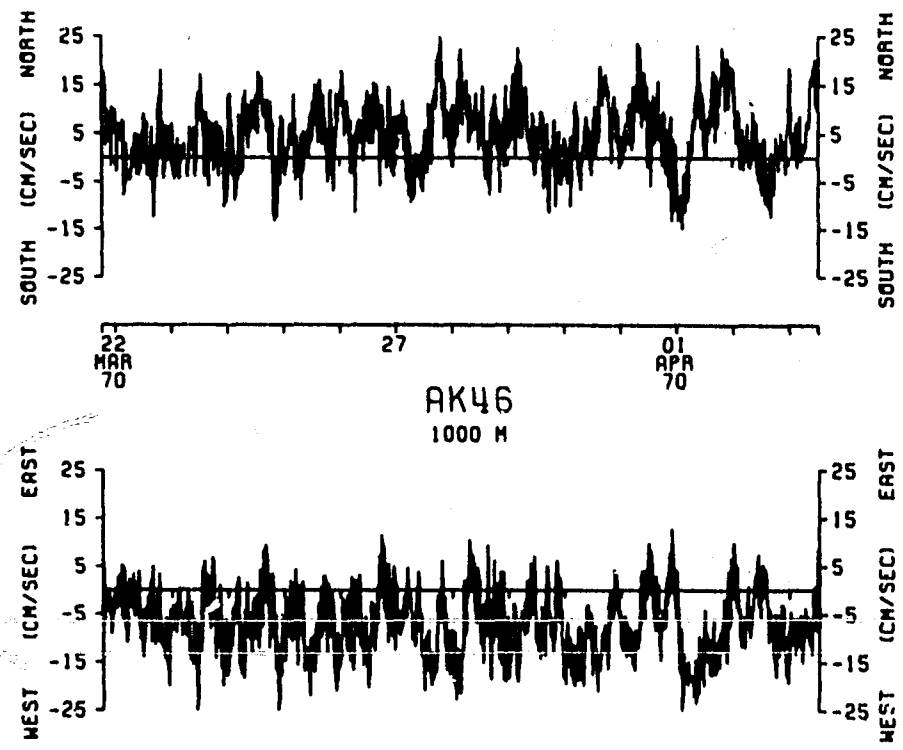

AK46
ALEXAEV

DATA 0400
SAMPLE SIZE = 10000-000 400/SEC
PLATTING BEGINS/ 70- 111-21 21-00-00
NO. OF DATA SAMPLES = 101
NUMBER OF INCLUSIVE DATA SAMPLES = 0

STATS

E = EAST
N = NORTH

UNITS = MM/SEC

UNITS = MM/SEC

DATE	MID TIME			MEAN (E)	MEAN (N)	VECTOR MEAN	VARIANCE (E)	VARIANCE (N)	VECTOR VARIANCE	COVARIANCE (E & N)	SPEED	
	HR	MIN	SEC								MEAN (E)	VARIANCE
70-111-22	18	1	0	-67.	21.	70.	4182.10	3543.01	4863.05	221.35	121.	110.93
70-111-23	18	1	0	-71.	25.	78.	3613.82	3649.01	3221.27	208.31	110.	186.65
70-111-24	18	1	0	-83.	37.	70.	1821.46	3279.87	2548.01	826.66	99.	177.25
70-111-25	18	1	0	-64.	24.	72.	1308.37	1675.44	1439.41	888.11	90.	194.12
70-111-26	18	1	0	-81.	21.	72.	2050.67	1240.85	1643.76	308.63	91.	243.36
70-111-27	18	1	0	-67.	28.	72.	1644.18	2489.84	2827.82	-219.81	101.	291.28
70-111-28	18	1	0	-84.	28.	76.	2849.19	1799.08	2154.10	775.67	98.	363.18
70-111-29	18	1	0	-84.	27.	63.	1800.87	2166.06	1843.82	-127.95	86.	267.38
70-111-30	18	1	0	-71.	36.	80.	903.11	1108.74	1008.92	688.08	90.	290.61
70-111-31	18	1	0	-26.	48.	89.	2417.18	2028.24	2220.71	-41.46	88.	162.49
70-IV-1	18	1	0	-63.	36.	91.	922.86	3437.76	2180.17	644.67	109.	249.88

STATS

*** EAST ***
*** MM/SEC ***

MEAN = -62.37 STD ERR = 1.49
VARIANCE = 2285.36
STD. DEV. = 47.60
KURTOSIS = 0.08
SKEWNESS = 1.245

*** NORTH ***
*** MM/SEC ***

MEAN = 23.27 STD ERR = 1.62
VARIANCE = 2605.72
STD. DEV. = 51.02
KURTOSIS = 3.11
SKEWNESS = -1.677

*** SPEED ***
*** MM/SEC ***

MEAN = 94.75 STD ERR = 0.87
VARIANCE = 334.66
STD. DEV. = 18.29
KURTOSIS = 2.91
SKEWNESS = 0.566

*** EAST *** AK47A
*** MM/SEC ***

COVARIANCE = 2200 STD ERR = 102.42
STD. DEV. OF COVARIANCE = 3277.55
CORRELATION COEFFICIENT = 0.172

***** VECTOR MEANS *****
***** EAST & NORTH *****

MEAN = 76.69
VARIANCE = 2475.59
STD. DEV. = 49.75

SAMPLE SIZE = 1324 POINTS

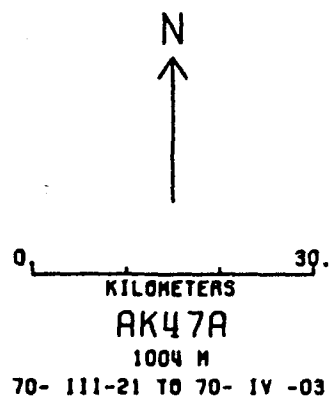

KINETIC ENERGY DENSITY $\frac{CM^2}{SEC^2}$ C.P.H.

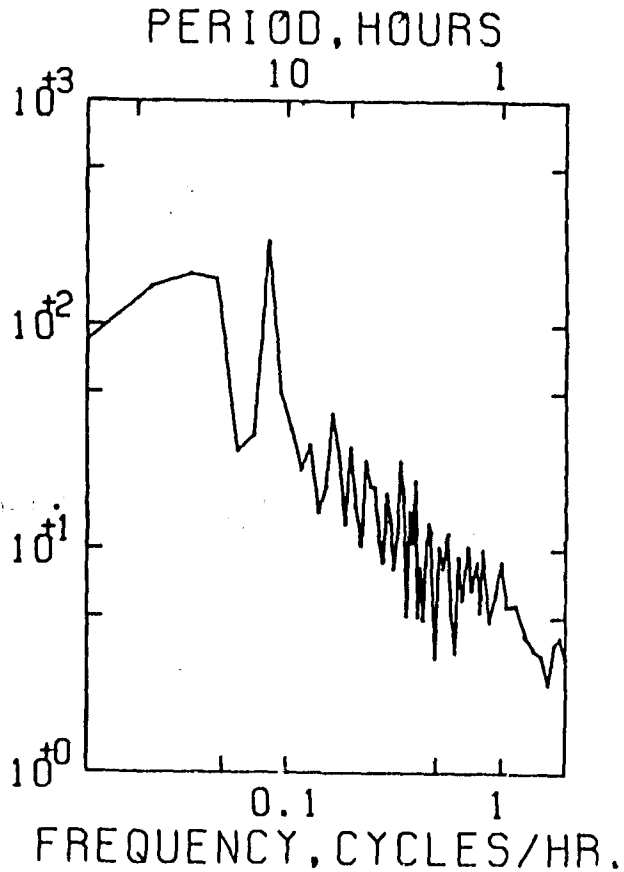

AK47A
BRAINCON

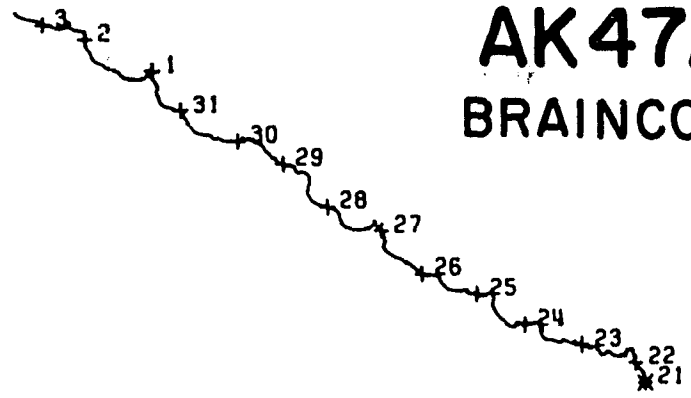

TIME WESTGAGE DATA/ AK47A PLATTINUM BRINCON 73-111-01 01-01-00

TIME	DIRECTION	VELOCITY	TIME	VELOCITY
00	0	0	00	0
01	0	0	01	0
02	0	0	02	0
03	0	0	03	0
04	0	0	04	0
05	0	0	05	0
06	0	0	06	0
07	0	0	07	0
08	0	0	08	0
09	0	0	09	0
10	0	0	10	0
11	0	0	11	0
12	0	0	12	0
13	0	0	13	0
14	0	0	14	0
15	0	0	15	0
16	0	0	16	0
17	0	0	17	0
18	0	0	18	0
19	0	0	19	0
20	0	0	20	0
21	0	0	21	0
22	0	0	22	0
23	0	0	23	0
24	0	0	24	0
25	0	0	25	0
26	0	0	26	0
27	0	0	27	0
28	0	0	28	0
29	0	0	29	0
30	0	0	30	0
31	0	0	31	0
32	0	0	32	0
33	0	0	33	0
34	0	0	34	0
35	0	0	35	0
36	0	0	36	0
37	0	0	37	0
38	0	0	38	0
39	0	0	39	0
40	0	0	40	0
41	0	0	41	0
42	0	0	42	0
43	0	0	43	0
44	0	0	44	0
45	0	0	45	0
46	0	0	46	0
47	0	0	47	0
48	0	0	48	0
49	0	0	49	0
50	0	0	50	0
51	0	0	51	0
52	0	0	52	0
53	0	0	53	0
54	0	0	54	0
55	0	0	55	0
56	0	0	56	0
57	0	0	57	0
58	0	0	58	0
59	0	0	59	0
60	0	0	60	0
61	0	0	61	0
62	0	0	62	0
63	0	0	63	0
64	0	0	64	0
65	0	0	65	0
66	0	0	66	0
67	0	0	67	0
68	0	0	68	0
69	0	0	69	0
70	0	0	70	0
71	0	0	71	0
72	0	0	72	0
73	0	0	73	0
74	0	0	74	0
75	0	0	75	0
76	0	0	76	0
77	0	0	77	0
78	0	0	78	0
79	0	0	79	0
80	0	0	80	0
81	0	0	81	0
82	0	0	82	0
83	0	0	83	0
84	0	0	84	0
85	0	0	85	0
86	0	0	86	0
87	0	0	87	0
88	0	0	88	0
89	0	0	89	0
90	0	0	90	0
91	0	0	91	0
92	0	0	92	0
93	0	0	93	0
94	0	0	94	0
95	0	0	95	0
96	0	0	96	0
97	0	0	97	0
98	0	0	98	0
99	0	0	99	0
00	0	0	00	0

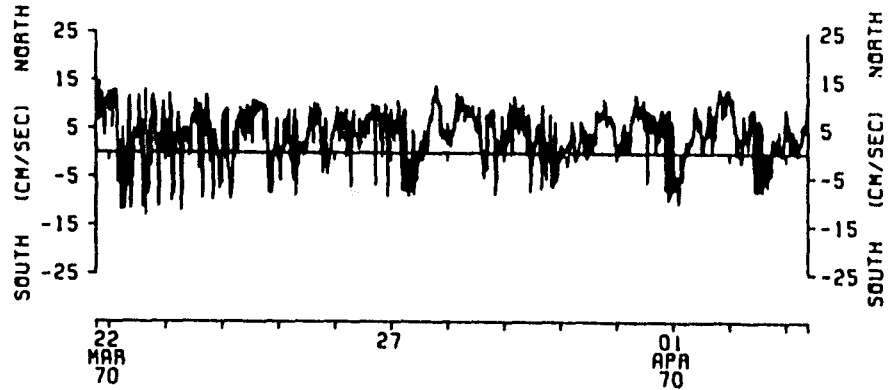

AK47A
BRAINCON

DATA/ AK47A
SAMPLE SIZE = 1000000
SPANNING RANGE
FROM 70-111-01 01-01-00
TO 70-111-01 01-01-00
AVERAGE NUMBER OF SAMPLES = 10
TOTAL NUMBER OF DATA SAMPLES = 100
NUMBER OF RECORDS ON TAPE = 0
NUMBER OF OBSERVATIONS = 0